



1. 使用環境條件

Apply Environmental Condition :

No.	項目 item	規格 standard
1-1	保存溫度 Storage Temperature Range	-20°C ~ 60°C
1-2	操作溫度 Operating Temperature Range	-10°C ~ 50°C
1-3	操作電壓 Operating Voltage Range	4.8V ~ 7.4V

2. 測試環境

Standard Test Environment :

2-1	測試環境 Standard Test Environment	每一个检查必须是正常的温度和湿度进行测量，温度 25 ± 5°C，相对湿度 65 ± 10%，在按照本规范的标准测试条件下判断特征。 Every characteristic of the inspect must be normal temperature and humidity carry out the test , temperature 25±5°C and relative humidity 65±10% of judgment made in accordance with this specification standard testing conditions.
-----	-----------------------------------	--

3. 外觀檢查

Appearance Inspection :

No.	項目 item	規格 standard
3-1	外觀尺寸 Outline Drawing	尺寸见附件 Dimension see the attachment
3-2	外觀 Appearance	无损坏，不允许影响功能 No damage which affects functions allowed



4. 電氣特性

Electrical Specification (Function of the Performance) :

No.	項目 item	6.0V	7.4V
4-1	空載轉速 Operating speed (at no load)	0.12 sec/60°	0.10 sec/60°
4-2	空載電流 Running current (at no load)	60 mA	80 mA
4-3	停止扭力 Stall torque (at locked)	2.2 kg-cm	2.6 kg-cm
4-4	停止電流 Stall current (at locked)	550 mA	700 mA
4-5	待機電流 Idle current (at stopped)	5 mA	5 mA

注：項目 4-2 定义平均值时，伺服器无负荷运行

Note: Item 4-2 definition is average value when the servo running with no load

5. 機械特性

Mechanical Specification :

No.	項目 item	規格 standard
5-1	外觀尺寸 Overall Dimensions	见附件 See the drawing
5-2	機構極限角度 Limit angle	220° ± 10°
5-3	重量 Weight	16 ± 1g
5-4	導線規格 Connector wire gauge	#26 PVC
5-5	導線長度 Connector wire length	350 ± 5 mm
5-6	舵片規格 Horn gear spline	25T/φ5.8
5-7	舵片種類 Horn type	半臂 Single



Product Name
数字伺服器 Digital Servo

Model No.
TR-4

Version
V1

Page
2/3

6. 控制特性

Control Specification :

No.	項目	規格
6-1	控制系統 Control system	改变脉冲宽度 Pulse Width Modification
6-2	放大器種類 Amplifier type	数字控制器 Digital Controller
6-3	操作角度 Operating travel	90° (在 1000→2000 μ sec)
6-4	中立位置 Neutral position	1500 μ sec
6-5	脈波訊號虛位 Dead band width	5 μ sec
6-6	旋轉方向 Rotating direction	逆时针 (在 1500→2000 μ sec) Counterclockwise (when 1500→2000 μ sec)
6-7	脈波寬度範圍 Pulse width range	800→2200 μ sec
6-8	可作動角度範圍 Maximum travel	大约 170° (在 800→2200 μ sec) Approx 170° (when 800→2200 μ sec)

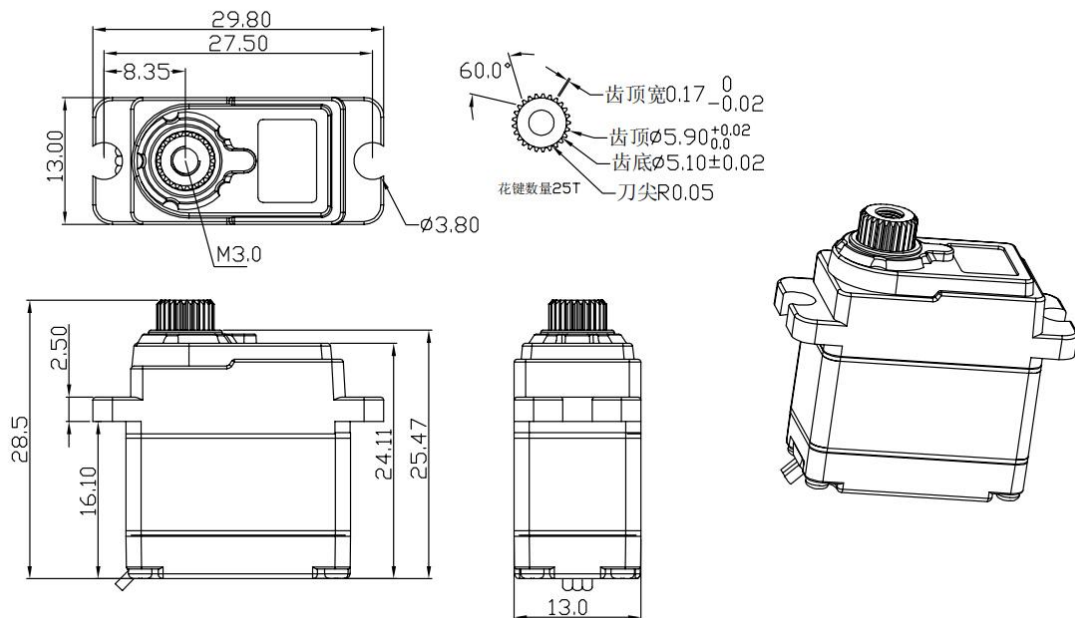

Product Name
数字伺服器 Digital Servo

Model No.
TR-4

Version
V1

Page
3/3