

Bugs 3 Mini



Brushless Drone

Instruction Manual



Brushless motor
(1306 2750KV)



4-in-1 ESC
(stuck and high-
temperature protection)



Two-direction 2.4GHZ
(weak signal and low voltage
remote controller alarm)

Important statement and safety guidelines

Thank you for purchasing MJX product. Please read this manual carefully before use and retain it for future reference.

Important statement

- This aircraft is not a toy, but hobby grade model. It should be assembled and operated properly. Pilot must operate this hobby model in safe way. Improper operation may cause injury or property damage.
- This aircraft is applicable for pilots aged 14+ who are with skilled flying experience.
- Users are in full charge of proper operating this aircraft. Manufacturer and dealers disclaim any responsibility for damages caused by misuse.
- Keep the small accessories away from kids to avoid accident.

Flight safety guidelines

Hobby grade radio control aircraft is somewhat considered to be the highest danger potential article. Users should firmly uphold the principle of “safety comes first”. Never fly the aircraft near airports, above crowds or in zones storing dangerous goods and understand the responsibility of the accident may cause by improper operations.

• Stay away from obstacles, crowds, power lines, trees or waters

Always choose a wide open area for every flight, well away from people and property. Never fly directly over people or animals. Please don't fly in such bad weather conditions as high temperature, snow, strong wind (\geq level 5), rain or fog. Maintain a 7ft (2m) distance from the aircraft when taking off and landing.

• Keep the aircraft in dry environment

The aircraft is composed by sophisticated electronic components and mechanical parts. To avoid damages on the mechanical and electronic components, please keep the aircraft in dry environment and use clean cloth to wipe the surface and keep it clean.

• Practice flying together with skillful pilot

Beginners are suggested to practice flying together with skillful pilot's guidance. Do not fly alone.

● Bear proper operation and safe flight guidelines in mind

Please take a careful look at the manuals before flights for important information of product functions and operation tips, and learn how to use the accessory, safe flight always comes first. Stay informed of and abide strictly by relevant local laws and regulations. Keep away from any non-flight zones and respect other people's privacy.

● Safe flying

Please make sure you are in good shape mentally before every flight. Fly the aircraft as per your flying experience. Never fly under influence of alcohol or drugs. Keep the remote controller at least 20 cm away from your body when flying the aircraft.

● Keep distance from a flying aircraft

Never use your hands to touch a flying aircraft under any circumstance. Don't approach and touch a landed aircraft before its propellers are completely locked.

● Keep away from heat source

The aircraft is made of metal, fiber, plastic, electronic component and other material. Please keep it away from the heat source to avoid deformation or even damage caused by sun exposure and high temperature.

● Environmental protection requirements

To protect our blue planet, so please recycle the aircraft as per local laws and regulations.

Product profile

Product configuration

Package includes

Aircraft (camera not included) X1	Extra Propellers A/B X2	Protection guard X4
Propeller changing tool X1	Charging converter X1	USB cable X1
Remote controller X1	Battery X1	Screw driver X1

Technical parameter of the aircraft

Diagonal: 175mm	Overall height: 65mm	Brushless motor: 1306 2750KV
Gross Weight: about 190g	Battery: 7.4V 850mAh 45C	Charging time: about 3~3.5 hours
Maximum flying time: about 10 minutes		

Product assemble

Propellers installation/removal

•Installation

Install propeller A and propeller B on the corresponding motor shaft and fix the rotor propellers tightly by rotating them as per the “lock” direction showed on the propellers.

•Removal

Fix the brushless motor by rotor blade changing tool and then rotate and remove the propellers as per the “unlock” direction showed on the propellers.

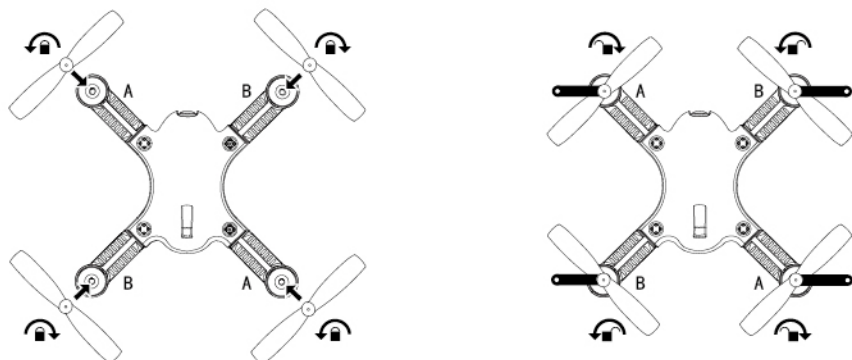

- ⚠ Please make sure that the clockwise and the counter clockwise propellers are installed on the correct motors, because the aircraft will not fly normally for wrong propellers installation.
- Be careful when installing the propellers, as they are a little sharp.
- Please use MJX propellers for this aircraft.
- Extra propellers can be ordered additionally.

Protection guard installation

Place the drone on flat surface and locate the two insertion position on the outer edge of the propeller arm; install the protection guard on each propeller arm by aligning the protection guard as shown; make sure that the protection guard is installed in the right position.

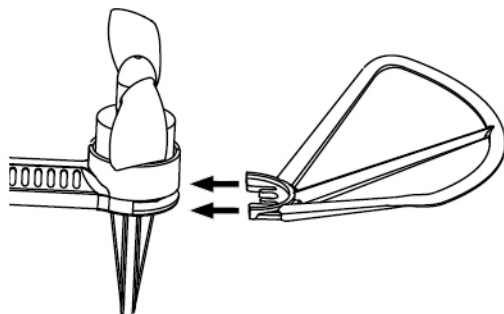

Battery installation and remove

Install the battery: Uncork the soft insulation plug from the power interface at the rear of the aircraft before the first use (indicated as pic. 1). Insert the battery into the battery compartment (indicated as pic.2). The aircraft will make beep sound with LED lights flashing; make sure that the battery is installed firmly and the lock is at the right position; failure to do this may result in safety problem during the flight.

Take out the battery: Press down the lock and take the battery out (indicated as pic. 3).

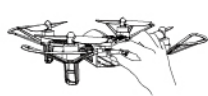

Pic. 1



Pic. 2



Pic. 3

⚠ Attention: The battery should be installed firmly, failure to do so may affect the flight safety of your aircraft. The aircraft may crash due to power-cut during the flight.

How to install the battery of remote controller

Open the battery door, install 4*AA batteries into the battery compartment according to the given polarity and then close the battery compartment.

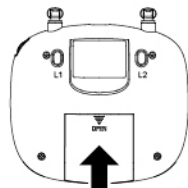
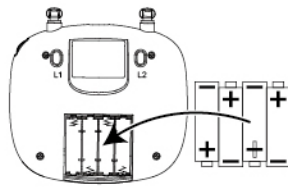
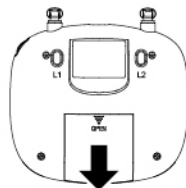

- ⚠**
- Insert batteries with correct polarity.
 - Non rechargeable batteries are not to be charged; the transmitter need 4*AA batteries for work.
 - Do not mix old and new batteries.
 - Do not mix alkaline, standard (carbon-zinc), or rechargeable (nickel-cadmium) batteries.
 - Rechargeable batteries are to be removed from the toy before being charged;
 - Rechargeable batteries are only to be charged under adult supervision;
 - Exhausted batteries are to be removed from the toy;
 - The supply terminals are not to be short-circuited.

How to charge the battery of aircraft

Step1: Slide the charging converter onto the battery and insert the pins into the battery charging plug;
Step2: Insert the white socket of the USB cable into the white plug of the converter;
Step3: Then, insert the plug of the USB cable into the USB socket of power adaptor to start charging.
The indicator light of the USB cable will be in red color and keeps solid on when charging is proceeding; when charging is finished, the indicator light will be off. Full charging takes about 3 to 3.5 hours.

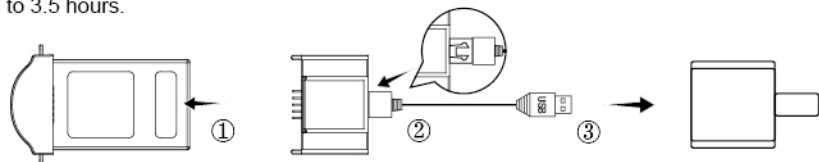



Battery

Charging converter

USB cable

Power adaptor (not included)

 Warm tips: We recommend using 5V 1A adaptor for charging.
It is not suggested to charge by computer.

-  •Need adult supervision when this model is being played by children.
- Only batteries of the same or equivalent type as recommended are to be used.
 - Insert batteries with correct polarity.
 - Non rechargeable batteries are not to be charged; the transmitter need 4*AA batteries for work.
 - Do not mix old and new batteries.
 - Do not mix alkaline, standard (carbon-zinc), or rechargeable (nickel-cadmium) batteries.
 - Rechargeable batteries are to be removed from the toy before being charged.
 - Rechargeable batteries are only to be charged under adult supervision.
 - Exhausted batteries are to be removed from the toy.
 - The supply terminals are not to be short-circuited.
 - The charging line to be used with the product should be regularly examined for potential hazard, such as damage to the cable or cord, plug, enclosure of other parts and that in the event of such damage, the product must not be used until that damage had been properly removed.
-

LED light installation

Open the upper cover and install the LED light in place (shown as pic. 1) and screw tightly by clockwise (shown as pic.2)

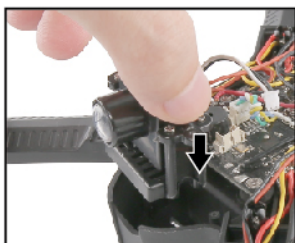

pic. 1

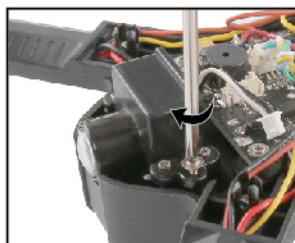

pic. 2

Major parts of the model

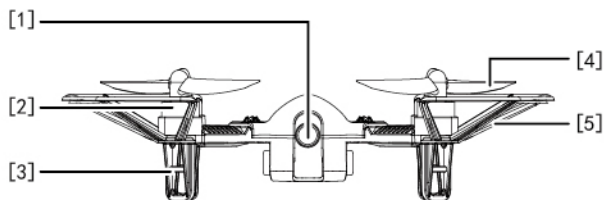

- [1] LED light
- [2] Brushless motor
- [3] Undercarriage
- [4] Propeller
- [5] Protection guard

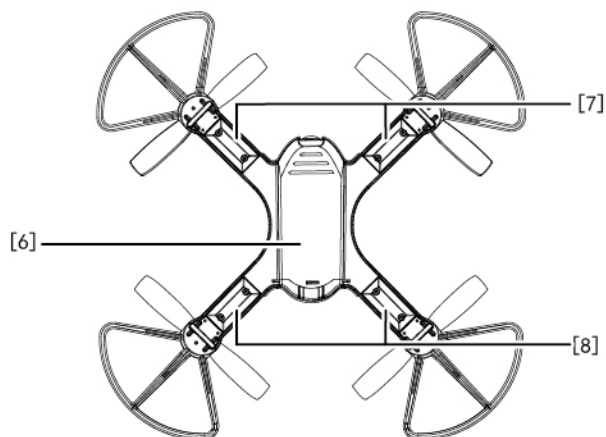

- [6] Battery compartment
- [7] Front light
- [8] Rear light

Major parts of the remote controller

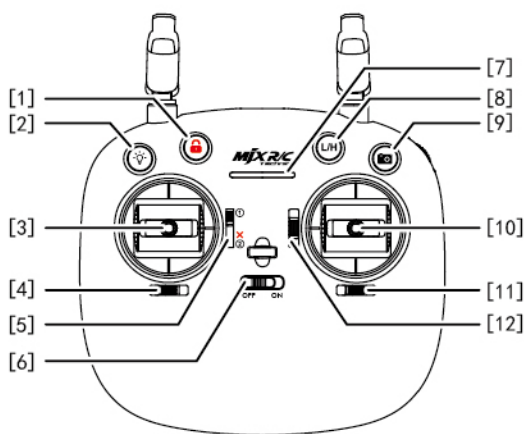

- [1] Unlock (short-press)/lock (long-press)
- [2] Light switch
- [3] Left stick
- [4] Turn left/right trimmer
- [5] Angle mode/Acro mode
- [6] Power switch
- [7] Power indicator
- [8] High/Low speed switch
- [9] Photo/shooting
- [10] Right stick
- [11] Leftward/rightward flight trimmer
- [12] Forward/backward trimmer

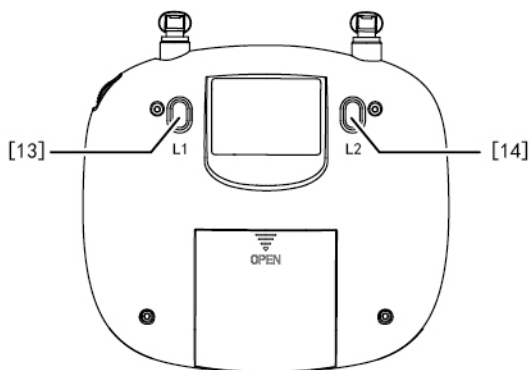

- [13] 3D flips & rolls button
- [14] Null button

Remote controller

How to connect the signal of the aircraft with the remote controller

- Keep pressing the red button and turn on the remote controller. The remote controller makes 2 beep sounds, and the indicator lights keeps flashing; the remote controller is under signal connection status.
- Turn on the aircraft. Once signal connection is done, the remote controller will send out a long beep sound and the indicator light keeps solid on.

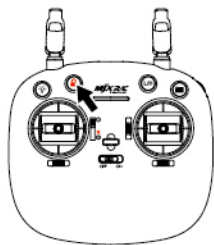

- Signal connection is done once for all if the remote controller is not linked to other aircraft.
- Set the connection one by one to avoid signal connection error.

Remote controller control stick calibration

1. Keep pressing the red locking button and turn on the remote controller.
2. Push down the calibration button (shown as pic.1) and hold on for 3 seconds, the remote controller will make 3 beep sounds and the indicator light of the remote controller turns from flashing quickly to slowly. Maximum rotate both of the left and right control stick to any direction for 2 circles (shown as pic.2).
3. Then, again, push down the calibration button and hold on for 3 seconds. The remote controller will send out 3 beep sounds and the indicator light of the remote controller turns from flashing slowly to quickly, which means that the control stick calibration is completed.

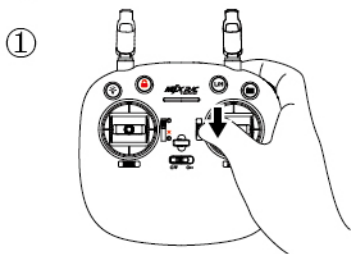

2



Warm tips: All remote controllers have been calibrated when manufacturing.

Remote controller calibration is requested only if pilots find that the remote controller control sticks are not working normally.

Attention: Please do not power on your aircraft when calibrate the control stick for the remote controller.

Aircraft gyro calibration

After the aircraft and the remote controller are banded, set the aircraft on flat ground and follow the indication photo as below to calibrate the gyro. Once the aircraft front lights turn from flashing to solid on, the gyro calibration is succeeded.

- This is not compulsory step. But it is recommended to do gyro calibration for every flight to obtain best flight experience.

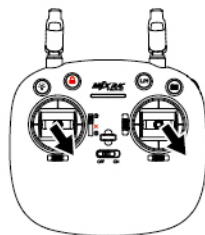
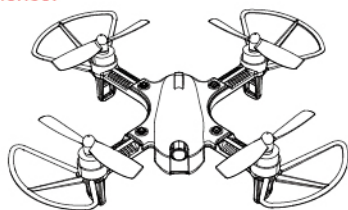

How to lock and unlock the aircraft

Unlock the aircraft

Once the aircraft and the remote controller are banded, the front lights of the aircraft keep solid on. Short-press the red button (indicated as below photo), the aircraft and the remote controller make a long beep sound; and the rear lights of the aircraft keep solid on; the motors rotate slowly, the aircraft is unlocked.

Lock the aircraft

Method 1: Pull down the throttle stick to the bottom position, long-press the red button (indicated as below photo). The remote controller sends out interrupted beep sound. Then, the motors stop rotating and the rear light is off, which means that the aircraft is locked.

Method 2: After the aircraft lands on the ground, pull down the throttle stick to the bottom position for 15 seconds; then, the motors stop rotating and the aircraft lock automatically. Once the aircraft is locked, it could not fly unless the motor is unlocked.

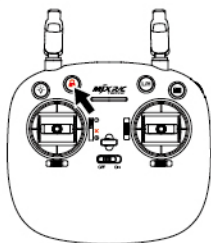

⚠ Warnings: The throttle control stick should be slid to the bottom position when long-press the red button to lock the aircraft. Otherwise, the aircraft could not be locked.

Angle Mode/Acro Mode

Angle mode:

Angle mode, also named as self-level mode, is an assisted flight mode where the flight controller would always attempt to put the aircraft in its neutral position when there is no user control. This means that with your hands off the controls, it will use 6-axis gyroscope to keep the aircraft level. The aircraft can perform flips and rolls by pressing the rolls button and operating joystick. It is suitable for beginner.

Acro mode:

Acro mode, as known as rate mode, doesn't level the aircraft automatically but always requires manual control during flight. Acro mode uses only the 3-axis gyro sensor. This is the more difficult mode for flying but also much more responsive. Acro mode is great for acrobatics such as flips and rolls. The aircraft can preform flips and rolls by operating joystick. It requires that pilot should be skillful enough and beginner is not suitable for Acro mode.

- Please choose flight mode before turn on the remote controller.

How to choose the flight mode:

Step 1. Slide the flight mode button to the top position of "①" or the bottom position of "②" before power on the aircraft and the remote controller. It is null at "X" position.

Step 2. Open the remote controller and install the battery of the aircraft.

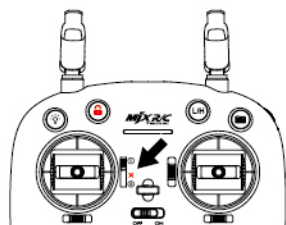

Pic. 1

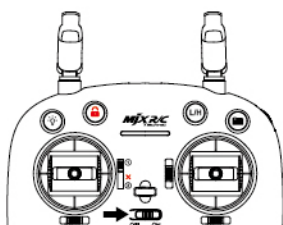

Pic. 2

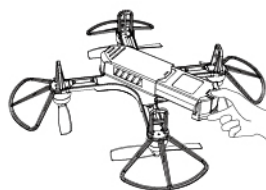

Pic. 3

⚠ Warm tips:

- Under Acro mode, the aircraft and the remote controller will make "beep beep beep" sound when it is in signal connection status.
- Acro mode is the more difficult flying mode, which is also much more responsive. It requires skillful pilots.

Operate the aircraft

Remote controller	Aircraft	Remote controller	Aircraft
	<p>Ascent</p> <p>Descent</p>		<p>Turn Right</p> <p>Turn Left</p>
	<p>Backward</p> <p>Forward</p>		<p>Left Side Flight</p> <p>Right Side Flight</p>

Flips & rolls

Flips & rolls operation

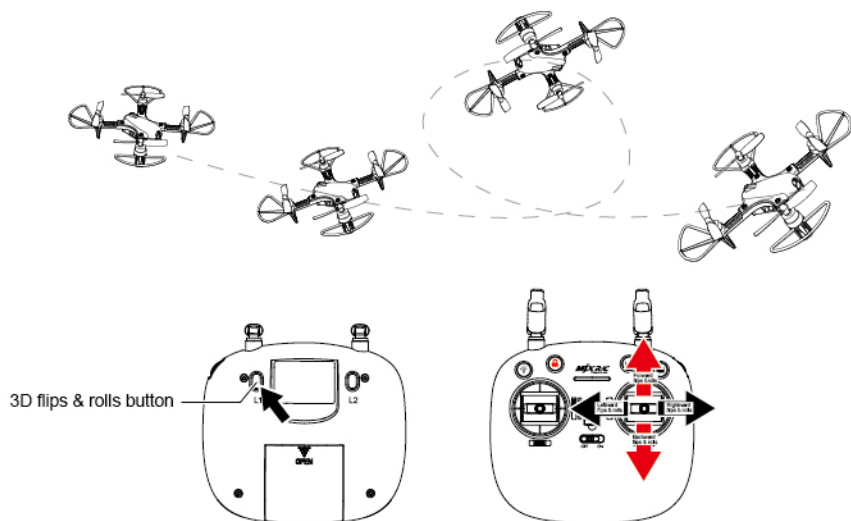

⚠ Warm tips: To flip and roll, please press down the 3D flips & rolls button and push the direction control stick at the same time. If not, the aircraft could not perform flips & rolls action normally.

How to fine-tune the aircraft

If the model keeps moving in any direction even this is no control signal given after flying, users may adjust the remote controller's trimmer button to keep the model balance.

Forward/backward trimmer

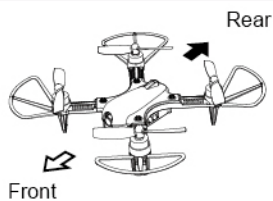

Turn left/ turn right trimmer

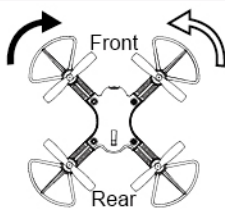
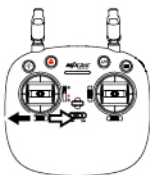

Leftward/rightward trimmer

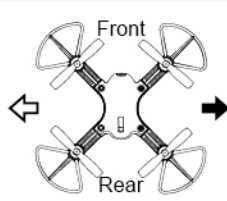
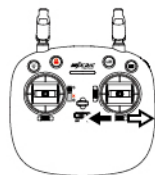

Status indicator

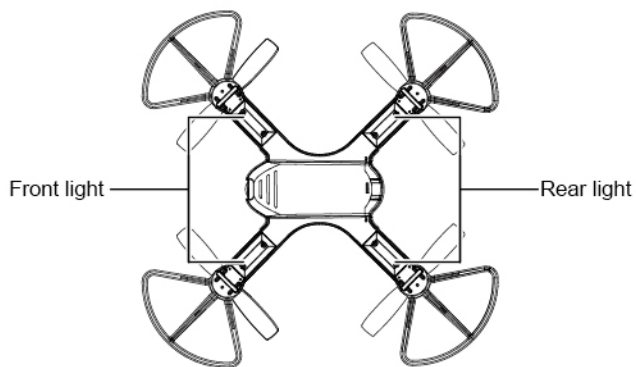

Sound of the drone	Status lights of the drone	Description
-	The front lights flash rapidly.	The gyro is under calibration status.
-	The front lights flash twice and stop for 2 seconds.	The aircraft is not linked to remote controller or the signal of the remote controller is lost.
The aircraft sends out "beep... beep... beep... beep" continuously.	The front lights flash slowly or the front/rear lights flash at the same time.	The aircraft is underpowered and the remote controller or the aircraft sends out "beep... beep... beep" sound.
-	The front lights keep solid on and the rear lights are off.	The aircraft is under lock status.
-	The front and rear lights keep solid on.	The aircraft is under unlocking or flying status.

Remote controller power indicator light description

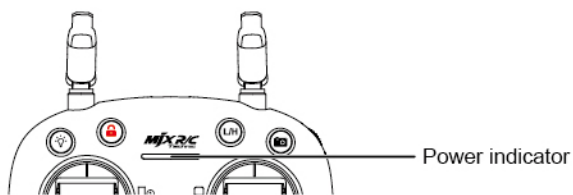

Remote controller sound	Power indicator	Description
Send out continuous beep sound quickly	On	<ol style="list-style-type: none"> The aircraft is too far away from the remote controller that resulted in weak receiving signal. The aircraft is powered off after successful signal connection.
Send out continuous beep sound slowly	On	The aircraft is in low voltage status.
Send out a long beep sound only	On	The remote controller has connected with the aircraft successfully.
Send out "beep beep" sound continuously	Flashing slowly	The remote controller is under power.
Send out "beep" occasionally	On	The aircraft receives very weak signal from the remote controller.

Flight

Before you take off, check and make sure that

- 1.The aircraft and the remote controller are full charged.
- 2.The propellers are installed correctly.
- 3.The motors work normally after unlocking.

Basic flight operations

Basic flight operations step

- 1.Connect the remote controller with the aircraft.
- 2.Unlock the aircraft after the detection of gyro of the aircraft is completed.
- 3.Pull up the throttle stick then the aircraft takes off, and control the aircraft flight by left/right stick.
- 4.Push the throttle stick to the bottom, lock the aircraft by press the lock button for long time.
- 5.Take out the battery from the aircraft.

Receiver PCB connecting diagram



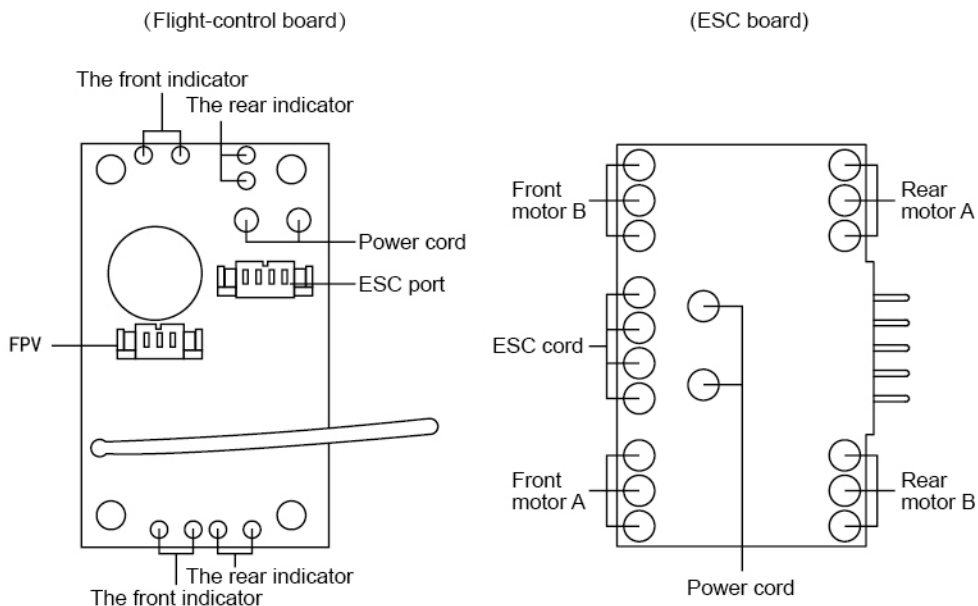









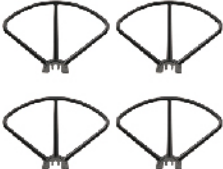
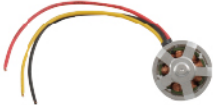

To make sure the drone works normally, the installation direction of the flight-control board and the connection location of the insertion wiring must be the same as shown below:

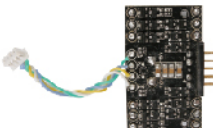

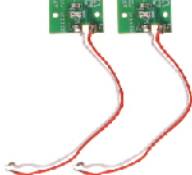



 Warnings: Please purchase MJX camera.

Product components

Basic parts

			
Upper cover MINI01	Main frame MINI02	Propeller A/B MINI03	Protection guard MINI04
			
Clockwise motor MINI05	Counter clockwise motor MINI06	Undercarriage MINI07	Bolt MINI08
			
ESC board MINI09	Front white light board MINI10	Rear blue light board MINI11	Lamp cover of the front and rear light MINI12
			
Flight-control board MINI13	Charging converter MINI14	USB cable MINI15	Battery MINI16

			
Screws pack MINI17	Soft insulation plug MINI18	Propeller changing tool B30017	Remote control GR6120E

Accessories

			
5G WIFI Camera C5007			

Trouble shooting

No.	Phenomenon	Solution
1	The lights are flashing quickly.	The Gyro of the model is under signal detecting condition, set the model to any flat surface.
2	The model can't be kept balance after taking off and lean one side.	1) Adjust all trimmer buttons to the middle value. 2) Lay the model in the flat surface or flat ground and proofread the gyro of the model again.
3	The model is shaking fiercely.	The rotor blade is out of shape, change the propellers.
4	The drone fail to unlock, the rear indicator flash slowly.	The battery is under low power situation, please charge the battery full.
5	The model can't be locked.	1) Push the throttle stick to the bottom first, then press the lock button for long time. 2) Proofread the stick of the remote control then push the throttle stick to the bottom, later press the lock button for long time.

Note:

- a) Changes or modifications not expressly approved by the party responsible for compliance could void the user's authority to operate the equipment.
- b) This equipment has been tested and found to comply with the limits for a Class B digital device, pursuant to part 15 of the FCC Rules. These limits are designed to provide reasonable protection against harmful interference in a residential installation. This equipment generates, uses and can radiate radio frequency energy and, if not installed and used in accordance with the instructions, may cause harmful interference to radio communications. However, there is no guarantee that interference will not occur in a particular installation. If this equipment does cause harmful interference to radio or television reception, which can be determined by turning the equipment off and on, the user is encouraged to try to correct the interference by one or more of the following measures:
- Reorient or relocate the receiving antenna.
 - Increase the separation between the equipment and receiver.
 - Connect the equipment into an outlet on a circuit different from that to which the receiver is connected.
 - Consult the dealer or an experienced radio/TV technician for help.



MADE IN CHINA