

Bugs 5W



Bugs Series Brushless Drone with GPS

User Manual



5G
WIFI
1080P FHD 200-300M
Farther, Faster, Clearer
(This camera works with 5G WIFI only.
Please make sure that your device
supports 5G WIFI.)

GPS & Maps



Point of interest



Follow me



One-key return



1080P 5G WIFI
Camera



GPS Positioning



Brushless motor
(1606 1500KV)



Independent ESC
(stuck and high-temperature protection)



2.4GHz two-way
communication
(weak signal alarm, low voltage alarm)



Important statement and safety guidelines

Thank you for purchasing MJX product. Please read this manual carefully before use and retain it for future reference.

Packaging has to be kept since it contains important information.

Important statement

- This aircraft is not a toy, but hobby grade model. It should be assembled and operated properly. Pilot must operate this aircraft in safe way. Improper operation may cause injury or property damage.
- This aircraft is applicable for pilots aged 14+ who are with skilled flying experience.
- Users are in full charge of proper operating this aircraft. Manufacturer and dealers disclaim any responsibility for damages caused by misuse.
- Keep the small accessories away from kids to avoid accident.

Flight safety guidelines

Hobby grade radio control aircraft is somewhat considered to be the highest danger potential article. Users should firmly uphold the principle of “safety comes first”. Never fly the aircraft near airports, above crowds or in zones storing dangerous goods and understand the responsibility of the accident may cause by improper operations.

• Stay away from obstacles, crowds, power lines, trees or waters

Always choose a wide open area for every flight, well away from people and property. Never fly directly over people or animals. Please don't fly in such bad weather conditions as high temperature, snow, strong wind (\geq level 5), rain or fog. Maintain a 7ft (2m) distance from the aircraft when taking off and landing.

• Keep the aircraft in dry environment

The aircraft is composed by sophisticated electronic components and mechanical parts. To avoid damages on the mechanical and electronic components, please keep the aircraft in dry environment and use clean cloth to wipe the surface and keep it clean.

• Practice flying together with skillful pilot

Beginners are suggested to practice flying together with skillful pilot's guidance. Do not fly alone.

● Bear proper operation and safe flight guidelines in mind

Please take a careful look at the manuals before flights for important information of product functions and operation tips, and learn how to use the accessory, safe flight always comes first. Stay informed of and abide strictly by relevant local laws and regulations. Keep away from any non-flight zones and respect other people's privacy.

● Safe flying

Please make sure you are in good shape mentally before every flight. Fly the aircraft as per your flying experience. Never fly under influence of alcohol or drugs. Keep the remote controller at least 20 cm away from your body when flying the aircraft.

● Keep distance from a flying aircraft

Never use your hands to touch a flying aircraft under any circumstance. Don't approach and touch a landed aircraft before its propellers are completely locked.

● Keep away from heat source

The aircraft is made of metal, fiber, plastic, electronic component and other material. Please keep it away from the heat source to avoid deformation or even damage caused by sun exposure and high temperature.

● Environmental protection requirements

To protect our blue planet, so please recycle the aircraft as per local laws and regulations.

Product profile

Product configuration

Package includes

Aircraft X1	Balance charger X1	Undercarriage X4	Battery X1
Propeller changing tool X1	Remote controller X1	Screwdriver X1	USB cable X1
Extra Propellers A/B X2	Charging converter X1	Mobile phone holder X1	

Technical parameter of the aircraft

Diagonal: 250mm	Overall height: 95mm
Brushless motor: 1806 1500KV	Battery: 7.4V 1800mAh 25C
Maximum flying time: about 16-18 minutes	Charging Time: about 5 hours
Gross weight: about 410g (with undercarriage and battery)	

Product assemble

How to attach and detach the propellers

Attach propeller A:

Put the propeller with marking 'A' into the clockwise rotating motor shaft (the side marked A should be upwards). Then, put the silicone rubber ring into the center bore of the propeller. Last, choose the propeller screw with dot and put it into the motor shaft; tighten the screws by counter-clockwise.

Attach propeller B:

Put the propeller with marking 'B' into the counter-clockwise rotating motor shaft (the side marked B should be upwards). Then, put the silicone rubber ring into the center bore of the propeller. Last, choose the propeller screw without dot and put it onto the motor shaft; tighten the screw by clockwise.

Detach the propellers:

Hold the aircraft brushless motor and unscrew the screw without dot by counter-clockwise (screw with dot should be rotated by clockwise) to take apart the propeller.



Attention: Please install all fittings step by step as below pictures. Keep in mind that the propellers are distinguished by A & B mark and propellers screws are distinguished by dot mark. please pay attention to your rotation direction.

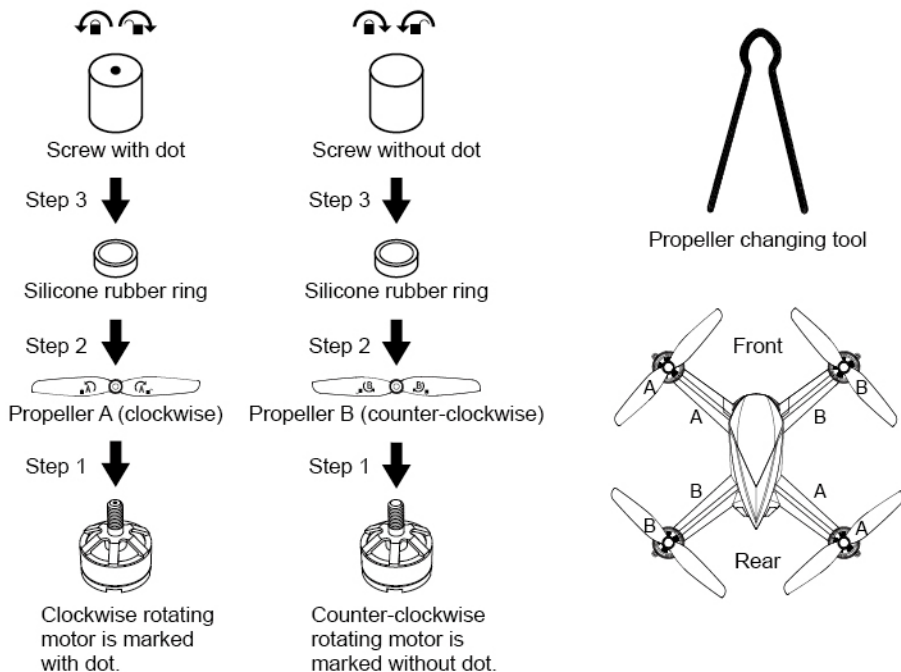

- Please make sure that the clockwise and the counter-clockwise propellers are installed on the correct motors, because the aircraft will not fly normally for wrong propellers installation.
- Be careful when installing the propellers, as they are a little sharp.
- Please use MJX propellers for this aircraft.
- Extra propellers can be ordered additionally.

Undercarriage installation

Insert the bulge of the undercarriage into the holes locating at the bottom of the motors and fix the screws by clockwise.

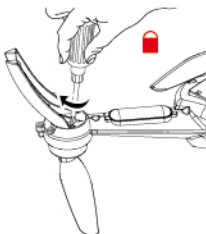

Battery installation

Slide the battery into the battery compartment at the rear of the aircraft by pushing with appropriate force, the aircraft will make beep sounds with LED lights flashing. Then, turn counter-clockwise of the lock knob locating at the rear of the battery to the “O” position to confirm the battery is installed firmly.

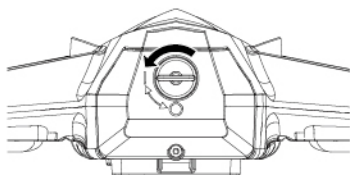
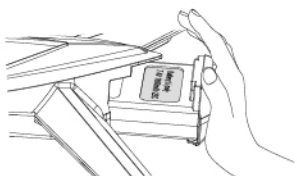

Attention: The battery should be installed firmly, failure to do so may affect the flight safety of your aircraft. The aircraft may crash due to power-cut during the flight.

How to remove the battery

Turn clockwise of the lock knob at the rear of the battery to “I” position; then put your thumb and index finger on the designated position and pull backward with appropriate force, the battery will be removed. To avoid slipping, please keep your finger and your aircraft dry and clean.

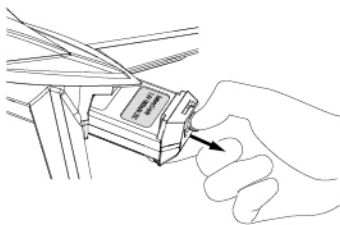
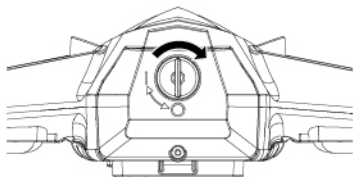

How to charge the battery of aircraft

- Step 1. Make sure that your power adaptor (5V 1-2A) is connected with the power outlet (indicated as Pic. 1);
- Step 2. Connect the balance charger to the power adaptor by plug-in the USB cable accordingly (indicated as Pic. 2);
- Step 3. Insert the white triplex-wire plug of the charging converter face up into the triplex-wire socket of the balance charger (indicated as Pic. 3);
- Step 4. Connect the battery to the charging converter and charging is started. Full charging time takes about 5 hours (indicated as Pic. 4).

- When charging is proceeding, the green light keeps flashing slowly and the red light keeps solid on.
- When charging is finished, both of the green light and the red light keep solid on.
- If the battery and charging converter is not connected with the balance charger, but the balance charger is connected with the adaptor, the red light keeps solid on and the green light is off.
- Once there is any malfunction, the red light will be solid on and the green light will keep flashing rapidly.

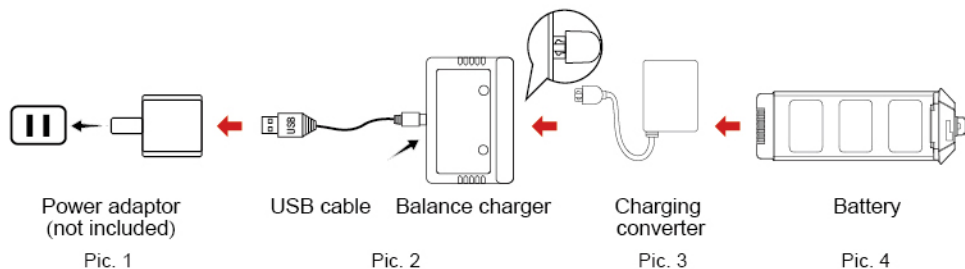

Warm tips:



- The battery plug should be connected correctly with face up(but not upside down) when plug into the balance charger; Failure to do so will result in battery cannot charge or charger damaged.
- We recommend using 5V (1-2A) adaptor for charging.
- It is not suggested to charge by computer.



- Need adult supervision when this aircraft is being played by children.
- Only batteries of the same or equivalent type as recommended are to be used.
- Insert batteries with correct polarity.
- Non rechargeable batteries are not to be charged; the transmitter need 4*AA batteries for work.
- Do not mix old and new batteries.
- Do not mix alkaline, standard (carbon-zinc), or rechargeable (nickel-cadmium) batteries.
- Rechargeable batteries are to be removed from the aircraft before being charged.

- Rechargeable batteries are only to be charged under adult supervision.
 - Exhausted batteries are to be removed from the aircraft.
 - The supply terminals are not to be short-circuited.
 - The charging line to be used with the product should be regularly examined for potential hazard, such as damage to the cable or cord, plug, enclosure of other parts and that in the event of such damage, the product must not be used until that damage had been properly removed.
-

How to attach and detach the camera

● Attach

- Step 1. Insert the white plug of the camera into the socket at the bottom of the aircraft (indicated as Pic. 1);
- Step 2. Insert the camera top cylindrical bulge into the slot at the bottom of the aircraft (indicated as Pic. 2); then turn clockwise 90 degrees of the camera to confirm the camera is installed firmly (indicated as Pic. 3).

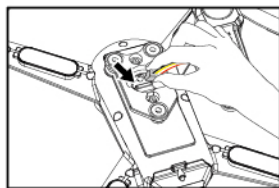

pic.1

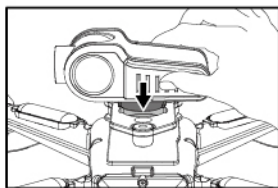

pic.2

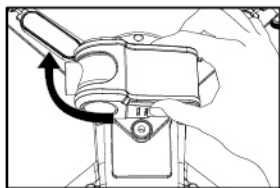

pic.3

● Detach

- Step 1. Hold the camera with your thumb and index finger and then turn counter-clockwise 90 degrees to take out the camera (indicated as Pic. 1);
- Step 2. Press on the buckle and take out the plug of the camera from the socket of the aircraft (indicated as Pic. 2).

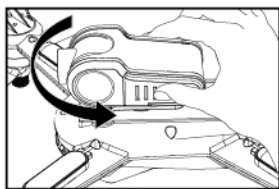

pic.1

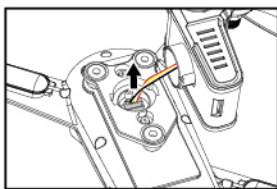

pic.2



Warm tips:

The camera works only with "Bugs Go" APP. Please turn to Page 18 for the APP download and installation. Beginners are suggested to press "Help" button to learn about the camera operation method.

Gimbal trimmer

The camera angle can be adjusted within a 90 degree range by operating the gimbal trimmer to obtain a better aerial experience. When scroll up the gimbal trimmer(upward to direction of "A"), the camera will tilt upward to the direction of A; when scroll down the gimbal trimmer(downward to direction of "B"), the camera will tilt downward to the direction of B.

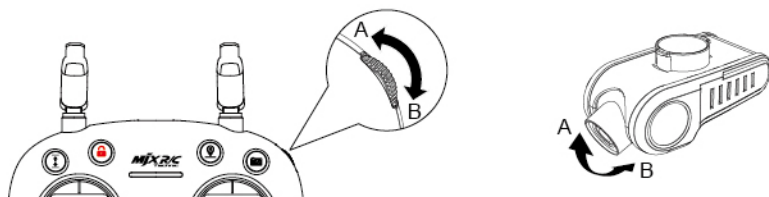

Warm tips:

Please adjust the camera to keep a horizontal level by operating the gimbal upward before landing on the ground.

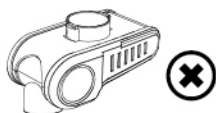
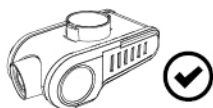

Major parts of the aircraft

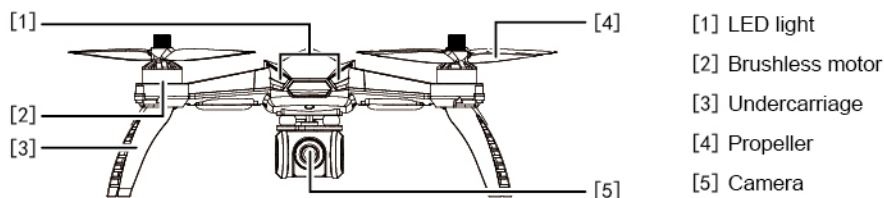

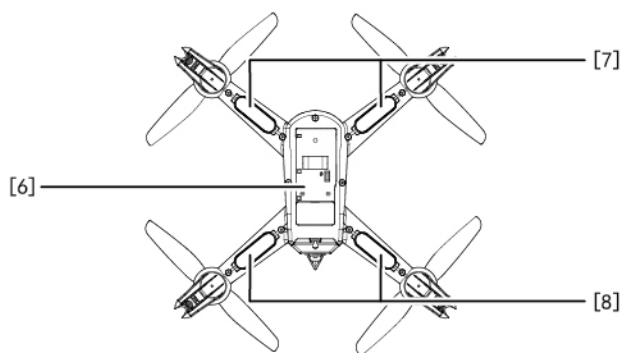

[6] Battery compartment

[7] Front light

[8] Rear light

Major parts of the remote controller

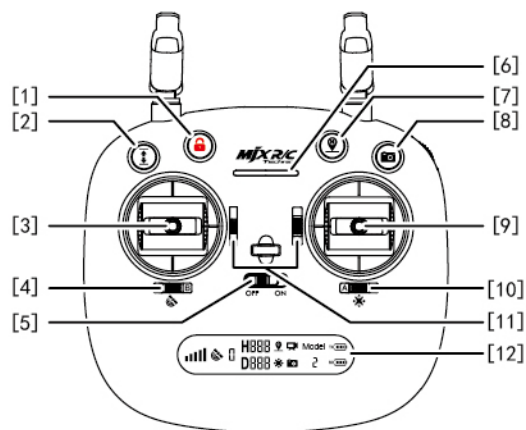

[1] One-key unlock

[2] One-key takeoff/
One-key landing

[3] Left stick

[4] Gesture/ GPS mode switch

[5] Power switch

[6] Power indicator

[7] One-key return

[8] Photo/shooting

[9] Right stick

[10] Headless mode switch

[11] Null button

[12] LCD display

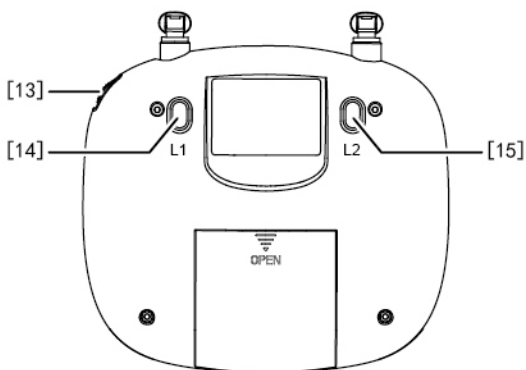

[13] Gimbal trimmer

[14] Null button

[15] Null button

LCD screen

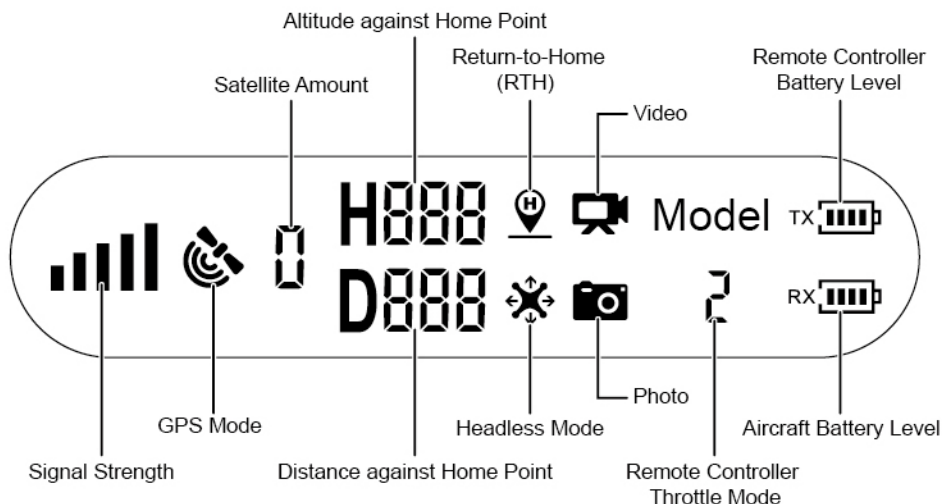

How to install the battery of remote controller

Open the battery door, install 4*AA batteries into the battery compartment according to the given polarity and then close the battery compartment.

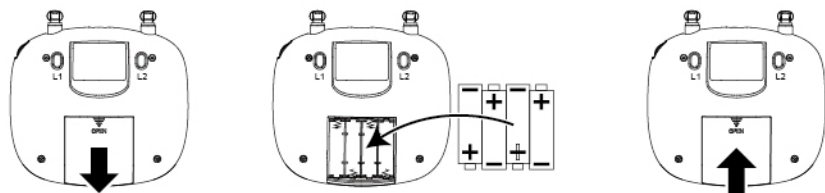

- Insert batteries with correct polarity.
- Non rechargeable batteries are not to be charged; the transmitter need 4*AA batteries for work.
- Do not mix old and new batteries.
- Do not mix alkaline, standard (carbon-zinc), or rechargeable (nickel-cadmium) batteries.
- Rechargeable batteries are to be removed from the aircraft before being charged.
- Rechargeable batteries are only to be charged under adult supervision.
- Exhausted batteries are to be removed from the aircraft.
- The supply terminals are not to be short-circuited.

How to connect the signal of the aircraft with the remote controller

Step 1: Keep pressing the red button “” and turn on the remote controller (indicated as Pic. 1). The remote controller makes 2 beep sounds, and the indicator light keeps flashing; the remote controller is under signal connection status.

Step 2: Power on the aircraft (indicated as Pic. 2). The aircraft will make beep sounds with front and rear lights flashing and will automatically link to the remote controller. Once the remote controller sends out a long beep sound and the indicator light of the remote controller turns from flashing to solid on and the signal icon “” is shown on the LCD screen, it means that signal connection is succeeded.

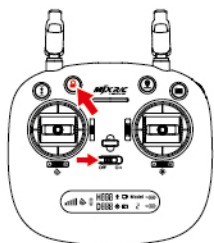

Pic. 1

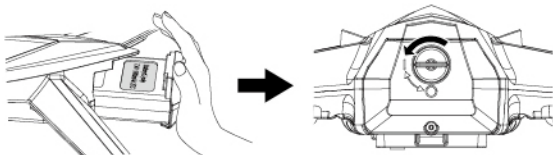

Pic. 2



- Signal connection is done once for all if the remote controller is not linked to other aircraft.
- Set the connection one by one to avoid signal connection error.

Throttle mode switch

Left hand throttle and right hand throttle are available for option at the remote controller. User can choose different control stick mode as per operation habit. There are 2 stick modes that could be found as below:

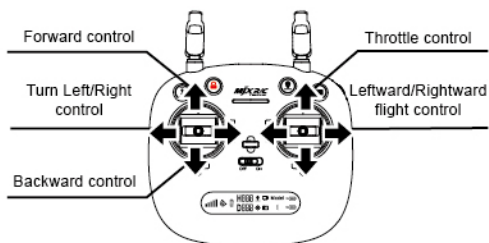

Mode 1

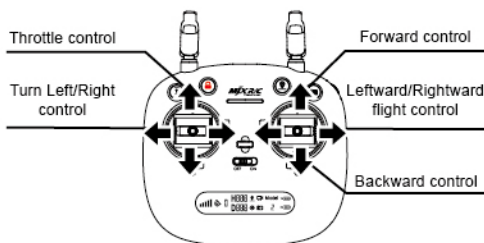

Mode 2

How to change throttle mode:

Step 1. Keep pressing the red button and turn on the remote controller, the remote controller is under signal connection status (indicated as pic.1);

Step 2. Keep pressing the RTH button “📍” for 3 seconds to choose the throttle control mode (indicated as pic.2). The throttle control mode will change according to each press. The mode number is shown on the LCD screen. The throttle control mode is set at mode 2 by default.

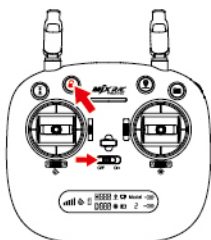

Pic. 1

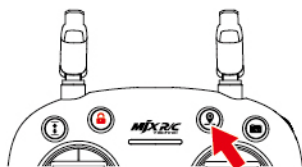

Pic. 2



Attention: To change the stick mode of the remote controller, please make sure that the remote controller is under signal connection status (the indicator light keep flashing). If not, the stick mode could not be changed.

Remote controller control stick calibration

Step 1. Keep pressing the red locking button and turn on the remote controller (indicated as pic.1);

Step 2. Press the calibration button for 3 seconds, the remote controller will make 3 beep sounds and the indicator light of the remote controller turns from flashing quickly to slowly. Maximum rotate both of the left and right control stick to any direction for 2 circles (indicated as pic.2);

Step 3. Then, again, press the calibration button for 3 seconds (indicated as pic.3). The remote controller will send out 3 beep sounds and the indicator light of the remote controller turns from flashing slowly to quickly, which means that the control stick calibration is completed.

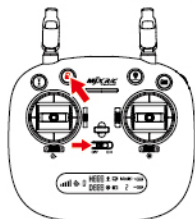

Pic. 1

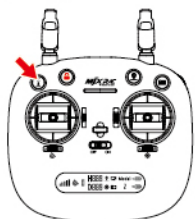

Pic. 2

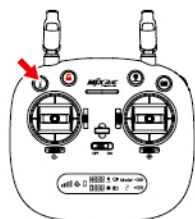

Pic. 3







Warm tips: All remote controllers have been calibrated when manufacturing.

Remote controller calibration is requested only if pilots find that the remote controller control sticks are not working normally.

Attention: Please do not power on your aircraft when calibrate the control stick for the remote controller.

Remote controller status indicator

No.	Remote controller status	Description
1	Indicator lights flash quickly.	The remote controller is under signal connection status.
2	Indicator lights flash slowly with steady beep..beep sound and the battery legend “  ” on LCD display flashing.	The remote controller is in low voltage status. Please change a full charged battery.
3	Battery legend “  ” on LCD display is as shown, with steady beep..beep...beep sound.	Battery is running out “  ”; the aircraft will return when the altitude is over 100m or the distance is over 300m.
4	Battery legend “  ” on LCD display is as shown, with steady long beep sound.	Battery is low “  ”; the aircraft will return when the altitude is over 15m or the distance is over 15m; if either the flying altitude or flying distance is less than 15m, the aircraft will land to the spot.
5	Signal strength on LCD display is less than two grids or no displaying; and the remote controller makes steady beep...beep...beep sound.	1.The distance between aircraft and remote controller is so long that the signal is weak. 2.The battery is removed after the aircraft connects to the remote controller.

Aircraft status indicator

No.	Indicator status	Meanings
1	Front and rear lights flash yellow rapidly.	Aircraft 2.4GHz disconnected.
2	Front and rear lights flash red, green and yellow alternatively.	Aircraft is in initialization detection status.
3	Front lights glow solid red, rear lights glow solid green.	No GPS signal, aircraft is in gesture mode.
4	Front light glows solid red, rear light glows solid green.	Good GPS signal, aircraft is preparing for GPS mode.
5	Front and rear lights flash green rapidly.	Aircraft is in gyroscope calibration status.
6	Front and rear lights flash yellow alternatively.	Aircraft is in compass horizontal calibration.
7	Front and rear lights flash green alternatively.	Aircraft is in compass vertical calibration.
8	Front light glows solid red, rear light flashes red slowly.	Aircraft is nearly low voltage, 1/4 battery level left.
9	Front light glows solid red, rear light flashes red rapidly.	Aircraft is in low voltage, only 1/6 voltage left.
10	Front and rear lights flash once, stop for 1.5 second.	Something wrong with the gyroscope.
11	Front and rear lights flash twice, stop for 1.5 second.	Something wrong with the barometer.
12	Front and rear lights flash three times, stop for 1.5 second.	Something wrong with the compass.
13	Front and rear lights flash fourth times, stop for 1.5 second.	Something wrong with the GPS module.

Aircraft initialization detection

After signal connection, the aircraft enters into initialization detection procedure with front and rear lights flashing red, green and yellow alternatively. Make sure that the aircraft is set on a flat and still surface for the initialization detection. The aircraft initialization detection takes about 8 seconds. Once the remote controller sends out "Di Di" sounds and the aircraft front and rear lights flash yellow alternatively, initialization detection is completed.



Attention: Make sure that the aircraft is set on a flat and still surface for the initialization detection.

Aircraft compass calibration

Attention:

1. Compass calibration should be performed after successful aircraft initialization detection.
2. Aircraft compass calibration should be done for every flight. That is to say, if changing new battery or the battery is reinstalled, compass calibration should be done again.

Two steps of compass calibration:

Step 1: Horizontal calibration

After successful aircraft initialization detection, the aircraft front and rear lights flash yellow alternatively. Hold the aircraft horizontally and rotate it 360 degrees along the central axis for about 3 circles. The aircraft front and rear light will change from flashing yellow alternatively to flashing green alternatively when horizontal calibration is completed.



Step 2: Vertical calibration

Hold the aircraft with camera facing up, and rotate it 360 degrees along the central axis for about 3 circles until the front and rear lights of the aircraft change from flashing to solid on, the compass calibration is successful.

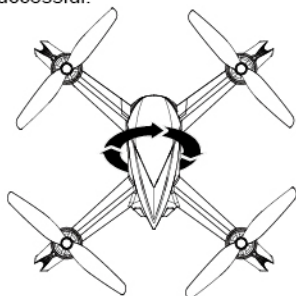



Attention: To fly at GPS mode, please choose an open and wide space for the flight, and make sure that the satellite amount is over 7.



- Please do not calibrate the compass in strong magnetic area, such as magnetic field, parking place or construction areas with underground reinforcement.
- Please do not carry magnetic materials with you (such as keys, cell phones, etc) when calibrating compass.
- Please keep away from big metal when calibrating compass.

Gyroscope calibration

After the aircraft and the remote controller are banded, set the aircraft on flat ground and follow the indication photo as below to calibrate the gyro. Once the aircraft front lights turn from flashing to solid on, it means that the gyro calibration is succeeded.



- The gyroscope calibration has been done by factory default. Gyroscope calibration is no need to be performed unless the aircraft can not exit the aircraft initialization detection procedure while the aircraft initialization detection is finished.
- Please make sure to set the aircraft on horizontal surface when performing calibration, failure to do this will affect the flight.

How to lock and unlock the aircraft

Unlock the aircraft:

There are 2 ways to unlock the aircraft that you can find it below:

- Method 1: Short-press the red button “” (indicated as Pic. 1). The motors rotate and the aircraft is unlocked.
- Method 2: Push the left stick to lower right corner and the right stick to the lower left corner at the same time (indicated as Pic. 2) to unlock the aircraft.

Lock the aircraft:

There are 2 ways to lock the aircraft that you can find it as below:

- Method 1: Long-press the red button “” (indicated as Pic. 1) for 3 seconds, the motors will stop rotating immediately and the aircraft is locked.
- Method 2: After the aircraft lands on the ground, pull down the throttle stick to the bottom position and keep for 3 seconds, the motors will stop rotating and the aircraft is locked.

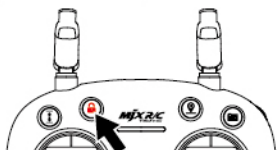

Pic. 1





Pic. 2



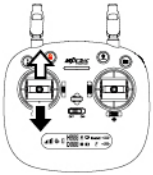
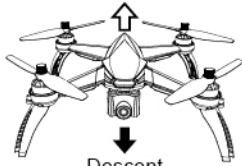
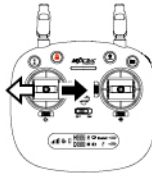
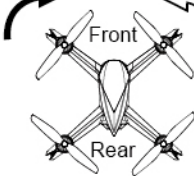

Warm tips: Please do not lock the aircraft by pressing the “” button directly during the flight, or the aircraft will be crashed.

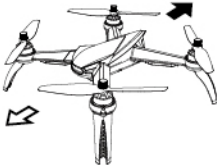
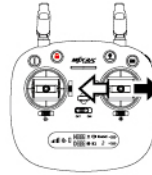
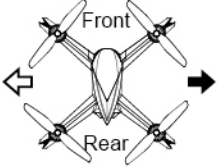
Operate the aircraft

Remote controller	Aircraft	Remote controller	Aircraft
	<p>Ascent</p>  <p>Descent</p>		<p>Turn Right</p>  <p>Turn Left</p>
	<p>Backward</p>  <p>Forward</p>		<p>Leftward flight</p>  <p>Rightward flight</p>

Flight mode

One-key takeoff/landing

- After the aircraft unlocked, short-press the “” button (indicated as below), the aircraft will automatically takeoff and hover at 1.5m altitude.
- When the aircraft is flying, short-press the “” button (indicated as below), the aircraft will automatically land on the ground.

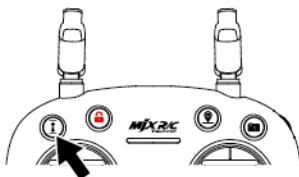

Gesture mode

Slide the button to position “A” (indicated as below), the aircraft is in Gesture mode that GPS is not used for positioning, and the aircraft only uses the barometer to maintain altitude. The aircraft will not fly with precise positioning and hovering. Gesture mode requests pilot with good skill.

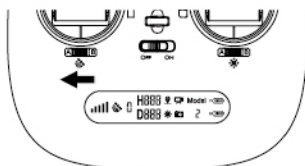

GPS mode

Slide the button to position “B” (indicated as below), the aircraft is in GPS mode and can precisely position and hover by the assistance of the GPS module.

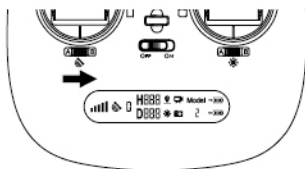

Headless mode

Slide the Headless mode switch button to position “B” (indicated as below); the aircraft enters into headless mode. When the aircraft is in headless mode, you're required to position the aircraft in such a way that its front is your front before the aircraft takes off. Then, when you take off the aircraft with the aircraft pointing to the front, you can give up worrying about orientation during flight.

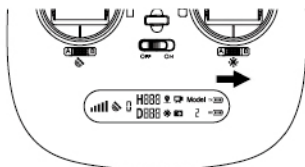

Return-To-Home (RTH)

The Return-to-Home(RTH) procedure brings the aircraft back to the last recorded Home Point. There are 3 types of RTH procedures: smart RTH, failsafe RTH and low battery RTH. The following sections describe them in detail.

	GPS	Description
Home Point		The Home Point is the location at which the aircraft takes off. A strong GPS Signal must be presented for the aircraft to record the Home Point.

Smart RTH

If the GPS signal is available (more than 7 satellites is presented) and the Home Point is recorded previously, press this button, the aircraft will fly back to the Home Point. During the smart RTH, you can use the remote controller to guide the aircraft around obstacles. You can press the RTH button again to exit RTH procedure and regain control of the aircraft.

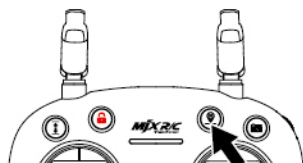

Failsafe RTH

If the GPS signal is available (more than 7 satellites is presented) and the Home Point is recorded previously. Failsafe RTH will be triggered if the remote controller signal is lost for more than 6 seconds, the flight-control system will control the aircraft automatically and the aircraft will fly back to the last recorded Home Point. You can regain control of the aircraft by press the RTH button if the remote controller signal is recovered.



- During the Failsafe RTH procedure, the aircraft can not avoid obstacles.
- The aircraft cannot Return-to-Home if the GPS signal is weak (satellite amount is less than 7).
- If there is no GPS signal and the remote controller signal lost for more than 6 seconds, the aircraft will not Return-to-Home but descend slowly until land to the ground and lock the aircraft.

Low voltage RTH



When the aircraft rear lights flash red slowly, battery icon “” is shown on the LCD screen, and steady beep, beep, beep..., beep, beep, beep sound is heard. At this moment, as long as the aircraft flying altitude is over 100 meters or the flying distance is over 300 meters, the aircraft will automatically fly back to the Home Point.

When the aircraft rear lights flash red slowly, battery icon “” is shown on the LCD screen, and steady beep..., beep..., beep sound is heard. At this moment, as long as the aircraft flying altitude is over 15 meters or the flying distance is over 15 meters, the aircraft will automatically fly back to the Home Point. If the aircraft flying altitude is less than 15 meters or the flying distance is less than 15 meters, the aircraft will automatically land to the ground.



Attention: When aircraft is in low voltage RTH status you can not regain control of the aircraft by pressing the RTH button.



Photo/Video

Short-press the button indicated as below and the camera icon “” on the LCD screen flashes once, the camera takes one photo; Long-press the same button, the video icon “” on the LCD screen flashes slowly, the camera is taking video. Long-press again will exit shooting.



Attention: When the aircraft is not inserted with TF card or the TF card is malfunction, photos and videos taking can not be done by pressing the button of the remote controller, but by the icon on the APP interface.

Low voltage warning

- When the battery icon “” is shown on the LCD screen, and the aircraft front lights glow solid on and the rear lights keep flashing slowly, it means that the battery is nearly low voltage.
- When the battery icon “” is shown on the LCD screen, and the aircraft front lights glow solid on and the rear lights keep flashing rapidly, it means that the battery is in low voltage.



Pic. 1



Pic. 2

Signal strength indicator

Signal strength “” shows the strength of the received signal. The more, the better.



Prepare the flight

Before you take off, check and make sure that

1. The aircraft and the remote controller are full charged.
2. The propellers are installed correctly.
3. The motors work normally after unlocking.

Basic flight operation steps

1. Connect the remote controller with the aircraft and then proceed aircraft initialization detection.
2. Aircraft compass calibration.
3. Unlock the aircraft after the gyro detection of the aircraft is completed.
4. Pull up the throttle stick then the aircraft takes off, and control the aircraft flight by left/right stick.
5. Pull down the throttle stick to the bottom position and keep for 3 seconds to lock the aircraft.
6. Pull out the battery from the aircraft and then turn off the remote controller.

FPV software download and installation

Where to download "Bugs Go" APP

- For Apple IOS system, please turn to Apple store, search "Bugs GO" or scan the QR code at right side to download the software.



- For Android system, please scan the "Google play" or "MJXRC.NET" QR code or search "Bugs Go" in "Google play" to download the software.



How to link the "Bugs Go" to the camera:

Power on the aircraft, then enter phone settings option. Turn on WiFi, find Bugs**** on the list and connect it. When "📶" legend is shown, it means WiFi connecting is successful. Exit settings and tap "Bugs Go" APP at your mobile device, then select your aircraft model on the home page; click "GO" to enter into the real-time image transmission interface.

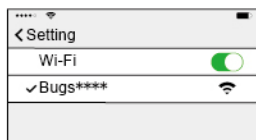

Connect WIFI



Bugs GO

Tap "Bugs Go" App



Click "GO"

Photos and video saving feature:

1. If the camera is without TF card, videos and photos will be saved at the APP.
2. If the camera is with TF card, videos and photos will be saved at the TF card.
3. Videos and photos in the TF card can be downloaded to the APP.



Attention: Please make sure that your mobile device supports 5G WIFI before linking Bugs Go to your device.

5G WiFi Channel Selection Guide

The product uses 5G WiFi and works at channels of 36 and 149. Factory default is set at the 36 channel.

Corresponding country/area available channel lists are as follows:

Channel	Frequency (MHZ)	USA	Europ	Japan	Singapor	China	Taiwan	South Korea
36	5180	Available	Available	Available	Available	Available	Available	Available
149	5745	Available	Disable	Disable	Available	Available	Available	Available





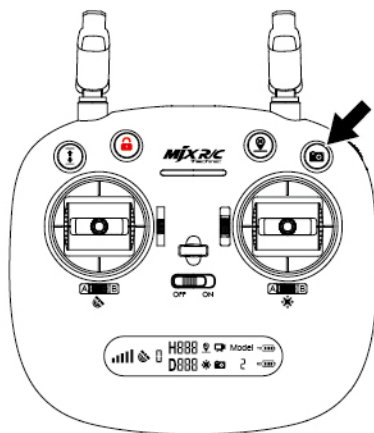









How to select channel

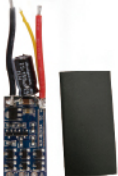
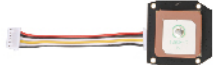





Connect the aircraft to the remote controller, and keep pressing the “📷” button on the remote controller for about 8 seconds, the remote controller makes “Di Di...Di Di Di” sound. Then, remain pressing the “📷” button for another 3 seconds, power off your aircraft. Turn on your aircraft again; it has changed to new channel already.



Product components

Basic parts

			
Upper cover B5W001	Main frame B5W002	Flight-control board B5W003	Undercarriage B5W004
			
Transparent front lamp cover B5W005	Front/rear light bar B5W006	ESC B5W007	GPS module B5W008
			
Clockwise motor B5W009	Counter-clockwise motor B5W010	Charging converter B5W011	Battery B5W012
			
Screws pack B5W013	Lamp cover of the front and rear light B5W014	Interleaving paper B5W015	Vibration-absorbed ball B5W016

			
Vibration-absorbed fixing connector B5W017	Clockwise propeller screws/ Counter-clockwise propeller screws B8PR04	Propeller A/B B80004	Propeller changing tool B80010
			
Silicone rubber ring B80017	Mobile phone holder C5000	Remote controller GR6221D	

Optional accessories

			
1080P 5G WIFI Camera C5021			

Trouble shooting

No.	Phenomenon	Solution
1	The lights are flashing quickly.	The Gyro of the aircraft is under signal detecting condition, set the aircraft to any flat surface.
2	The aircraft can't be kept balance after taking off and lean one side.	Lay the aircraft in the flat surface or flat ground and proofread the gyro of the aircraft again.
3	The aircraft is shaking fiercely.	The rotor propellers are out of shape, change the propellers.
4	The aircraft fails to unlock and the rear lights flash slowly.	The battery is under low power status, please charge the battery to full.

Note:

- a) Changes or modifications not expressly approved by the party responsible for compliance could void the user's authority to operate the equipment.
- b) This equipment has been tested and found to comply with the limits for a Class B digital device, pursuant to part 15 of the FCC Rules. These limits are designed to provide reasonable protection against harmful interference in a residential installation. This equipment generates, uses and can radiate radio frequency energy and, if not installed and used in accordance with the instructions, may cause harmful interference to radio communications. However, there is no guarantee that interference will not occur in a particular installation. If this equipment does cause harmful interference to radio or television reception, which can be determined by turning the equipment off and on, the user is encouraged to try to correct the interference by one or more of the following measures:
- Reorient or relocate the receiving antenna.
 - Increase the separation between the equipment and receiver.
 - Connect the equipment into an outlet on a circuit different from that to which the receiver is connected.
 - Consult the dealer or an experienced radio/TV technician for help.



MADE IN CHINA