

INSTRUCTION MANUAL

6 CH REMOTE CONTROL QUADCOPTER

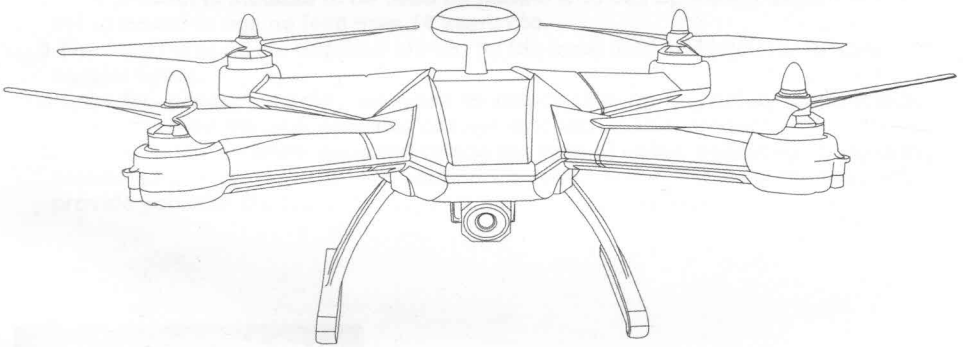

Key features of quadcopter

- Four-axis structure makes the quadcopter more flexible and rapid when flying. It is wind-resistant and can be flown indoor or outdoor.
- Built-in 6 axis gyroscope for precise hovering in the sky.
- Simple modular design makes changing parts easy.
- With 360° 3D eversion and throwing flight function.

Attention! This product has GPS function, players need to be outdoor flying to get full function, if fly indoor it will do not have GPS function.

The materials and specification mentioned in this instruction manual or the parts inside this package are for reference only.

PREFACE

Dear Customers:

Thank you for purchasing our flying model. Please read this instruction manual carefully in order to master the skill more quickly and operate this product more safely. In the mean time, please well keep the original of this instruction manual for future reference.

IMPORTANT INSTRUCTION

- 1.This product is not a toy but a precise equipment that integrating mechanics and electronics with expertise of aerodynamics and high-frequency transmitting. It requires to be correctly assembled and debugged so as to prevent the accident from being happened.The product owner should operate or control it in safe way. Please noted that we won't take any responsibility for any wrong operation as this may result in severe injury or loss of property and we can not control the operating process during the time when the user assemble or use this product.
- 2.This product is suitable to be used by people who has operating experience in flying model or age no less than 14 years old.
- 3.The flying ground we required should be the local field and legal for remote control flying.
- 4.Once this product is sold , we won't be responsible for any safety responsibility during the time the user operates or uses or controls this product.
- 5.If there is any problem occurred during the time of using, operating or repairing, please reach our sales agent for details.The sales agent that we authorized will provide you with the technical support and after-sale service.

SAFTY&CAUTIONS

This R/C flying model is a high dangerous commodity.Please make sure that it should be flided far away from the crowd.Please also pay more attention to the phenomenon such as incorrect assembly or damaged model or incorrect connection of electronic control equipment.Please also pay attention to the flying safety when operating and know more about the accident that may be happened due to your own negligence.

- 1.Keep it far away from the barrier or crowd.
- 2.Keep it far away from the moisten environment.
- 3.Use this product correctly and avoid operating by your own.
- 4.Keep it far away from the high-speed rotating part and heat source.
- 5.Please conform to the sequence of power ON/OFF.As the picture below shown, incorrect sequence of power ON/OFF may cause this product out of control and affect your own safety or others. Please form a good habit of switching on or switching off this product correctly.

GET TO KNOW YOUR TRANSMITTER

INTRODUCTION OF TRANSMITTER

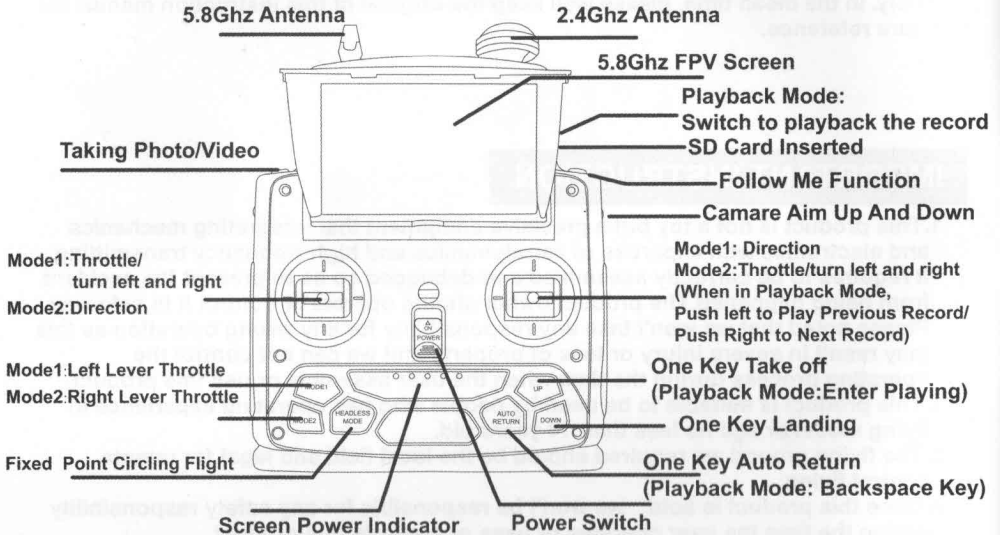

REMOTE CONTROL INSTALLING THE BATTERY

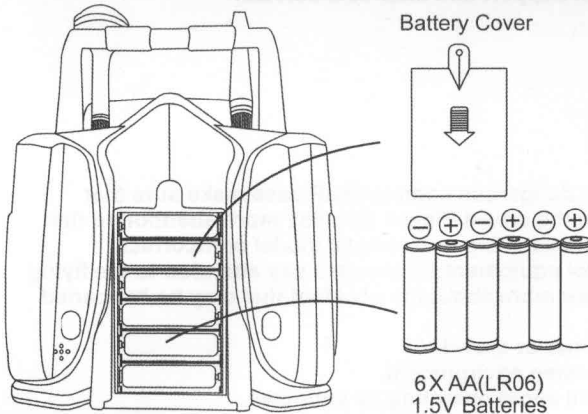

1. Open the battery cover
Install 6 "AA"
batteries (not included)
into the back of transmitter
than replace battery cover
and reinstall the screw.

1. Install batteries with correct polarity.
2. Do not mix old and new batteries.
3. Do not mix different types of batteries.

Please use the USB cable to charge the 5.8Ghz LCD Screen while the Screen Power Indicator light shows low power;
Connect the USB plug to the Charging Port on left back of controller.

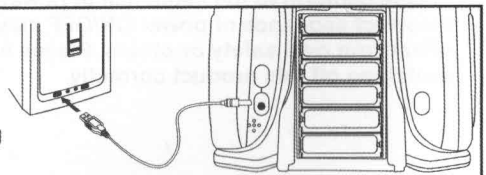

READY TO FLY YOUR QUADCOPTER

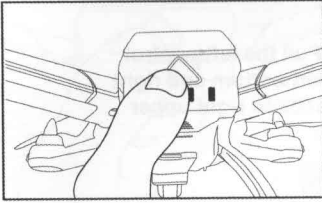

Step 1: Keep pressing the ON/OFF Switch on the drone 3 seconds to turn on it. (The indicator light will show how much power left)

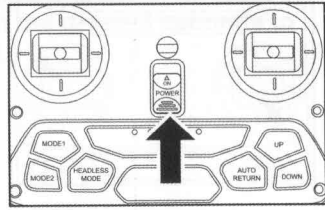

Step 2: Push the switch up to turn on the controller, once you hear voice "Di Di", means already match the channel.

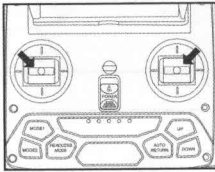

Step 3: Pull the left control stick to the right bottom and right control stick to the left bottom, the rotors will working, then you can push up the left control stick to make it take off.

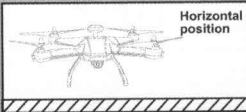

TIPS: When syncing your quadcopter keep it in a horizontal position to start a stable flight.

HOW TO LAND YOUR QUADCOPTER

Way 1: Press the Auto Back Home button;

Way 2: Pull down the left control stick to the bottom, about 5 seconds after touching the ground it will stop.

GEOMAGNETIC CORRECTION

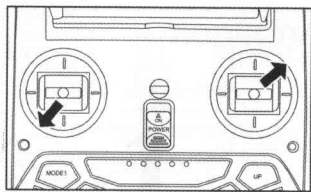

Step 1 : Pull the left control stick to left bottom and right control stick to right upper

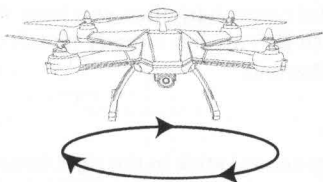

Step 2 : Keep the drone in horizontal position and clockwise circling for 3 times.

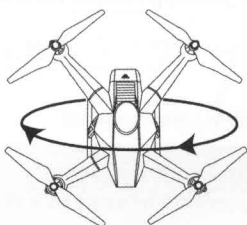

Step 3 : Make the drone head aim at ground, then clockwise circling for 3 times.

Tips: This process only be done if the drone can not fly according to controller.

CAUTIONS

1. When the indicator of transmitter keep light on but the indicator of quadcopter is blinking slowly, it means signal matching was not successful. Please turn off the power both of transmitter and quadcopter than restart the transmitter and quadcopter.
2. If the quadcopter is still flying to one side dramatically or spinning while hovering, please switch off the power of both the quadcopter and transmitter and then repeat the pre-flying steps.
3. When the indicator of the quadcopter keeps flashing slowly, it means that the quadcopter has entered into the low battery state. This time you need to charge the quadcopter with the USB cable provided.

CHARGE BATTERY OF QUADCOPTER

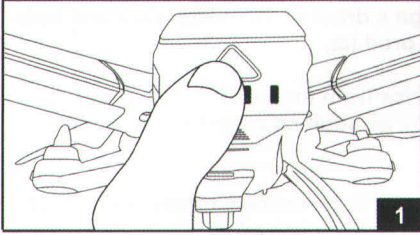

1. Keep pressing the ON/OFF Switch on the drone 3 seconds to turn off it.

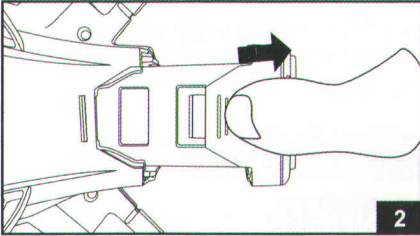

2. Pull out the battery from drone body.

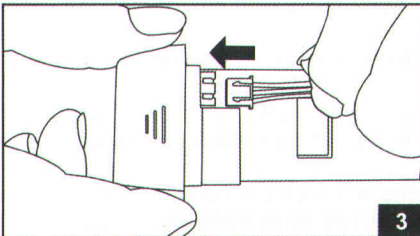

3. Connect the plug of adaptor to the battery plug.

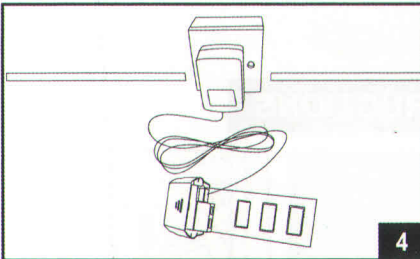

4. Connect the adaptor to power.

Caution:

When the indicator light on adaptor is red. means under charging; if the indicate turn to be green, means the battery already full charged.

Battery Charing time about 140 minutes - Flying time: Aboue 12-13 minutes!

CAUTIONS WHEN CHARGING

1. When charging, please put this product on a dried or ventilated area and keep it far away from heat source or explosive product.
2. When charging, please remove the batteries from the quadcopter. Then charging process should be supervised by an adult so as not to cause an accident.
3. After flying, please do not charge the battery if the surface temperature is still not cool. Otherwise it may cause a swollen battery or even a fire hazard.
4. Please make sure that you use the original USB charging cable provided. When the battery has been used for along time, or appears to be swollen, please replace them.
5. A battery when not in use for along time will lose its charge automatically. Charging or discharging too often may reduce the life of the battery.

BATTERY REPAIR & MAINTENANCE

1. Battery should be put in the dried or ventilated place with enviroment temperature about 18-25°C.
2. In order to enhance the using life of the battery, please avoid repeat charging or excessive discharging.
3. When the battery needs to be stored for a long time, please charge the battery first. That is to say, charge the battery for about 50%-60% of the volume and then well store it.
4. If you do not use it for more than 1 months, it s highly recommended that you need to check the battery voltage every month so as to make sure the voltage no less than 6.8V. Otherwise please do by following No.(3) mentioned.

CONTROLLER MODES & INSTRUCTIONS

Press the Fix Point Circling button, the drone will start to circling around the controller; Press again to quit out the mode.

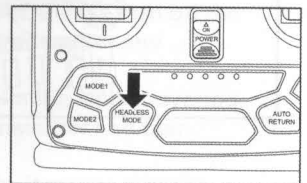

CHOOSE MODE 1 OR MODE 2 TO PLAY

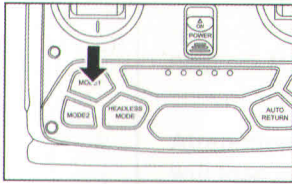

Mode 1

Controller Function of Mode 1

OPERATING DIRECTION

Hover up and down

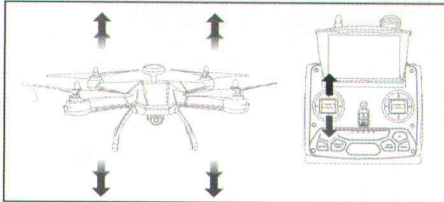

Push the throttle up or down, the quadcopter flies upward or downward.

Forward and backward

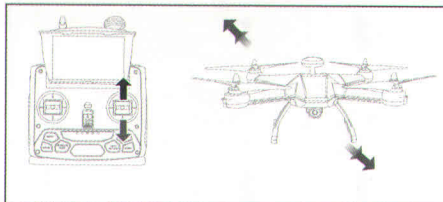

Push the direction lever up or down, the quadcopter flies forward or backward.

Turn Left and Right

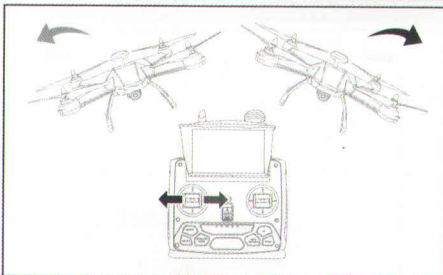

Pull the throttle left or right, the quadcopter turns to left or right.

Sideward fly

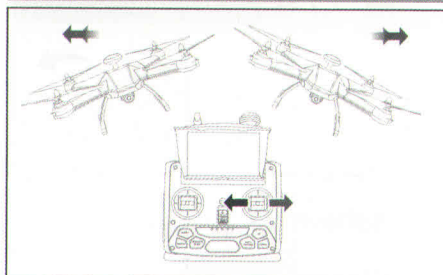

Pull the direction lever left or right, the quadcopter flies to left side or right side.

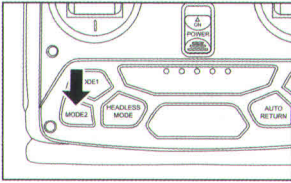

Mode 2

Controller Function of Mode 2

OPERATING DIRECTION

Hover up and down

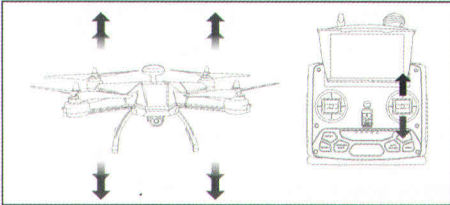

Push the throttle up or down, the quadcopter flies upward or downward.

Forward and backward

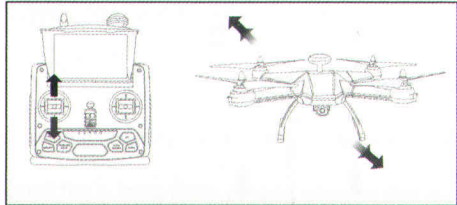

Push the direction lever up or down, the quadcopter flies forward or backward.

Turn Left and Right

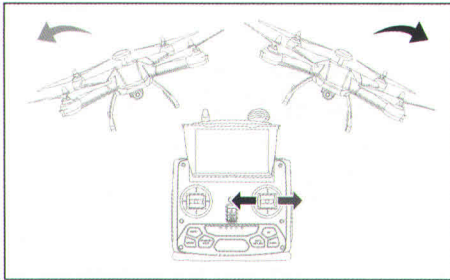

Pull the throttle left or right, the quadcopter turns to left or right.

Sideward fly

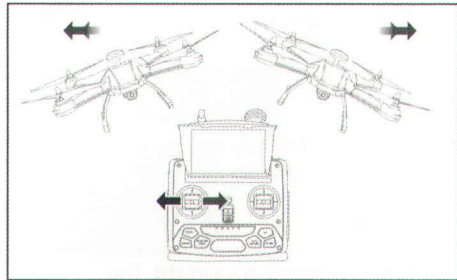

Pull the direction lever left or right, the quadcopter flies to left side or right side.

HOW TO PLAYBACK THE RECORDS

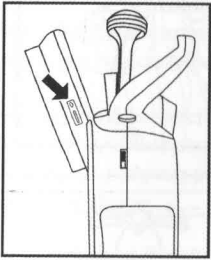

Playback Mode: Switch on 5.8Ghz LCD screen to playback

Attention! Once switch to playback mode, the drone will lose connect with controller, please do not press while flying the drone

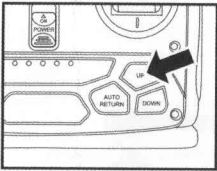

Playback Mode:
Enter Playing

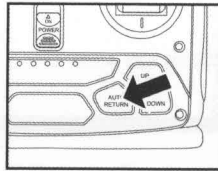

Playback Mode:
Backspace Key

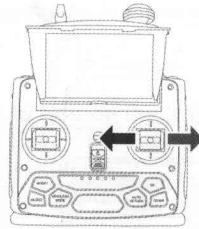

When in Playback Mode,
Push left to Play Previous Record/
Push Right to Next Record

HOW TO INSERT THE MEMORY CARD

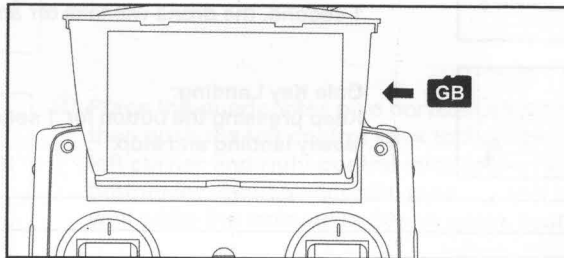
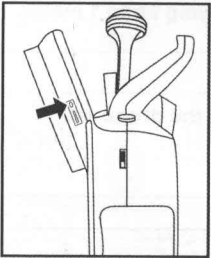

Insert the memory card in to the slot of screen on controller.

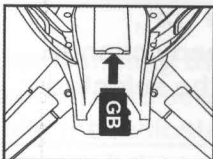

Please be sure to insert the memory card before start the drone, or it may can not work properly.

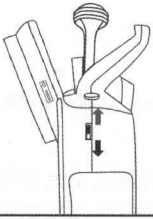

Press Up: Camera Aim Up
Press Down: Camera Aim Down

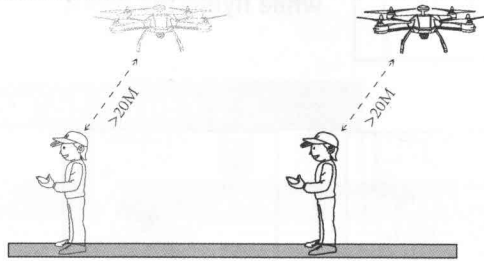
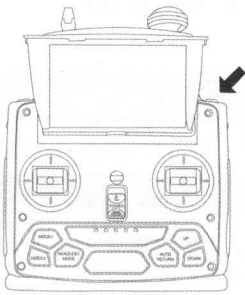
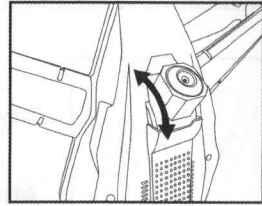

Be sure that the drone is more than 20 meters away from you, then press the Follow Me button, the drone will aim at you and follow you. You can quit out the Follow Me Mode by pressing again the button.

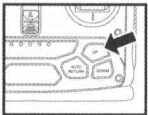

One Key Take Off:

Keep pressing the One Key Take Off / Landing button for 1 second, the drone will take off and flying up to 1 meter.

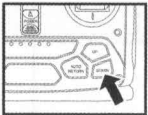

One Key Landing:

Keep pressing the button for 1 second the drone will slowly landing and stop.

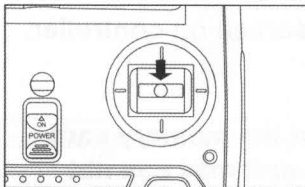

High / Low Speed:

Press the right control stick into the controller direction.

When you hear sound "Di", means the speed already change.

Only two speeds can be selected.

INTRODUCTION TO QUADCOPTER FUNCTIONS

070A

Low-voltage protection:

When the quadcopter battery is not enough, the rotors will be stopped power supply. As the quadcopter control system will protect battery automatically.

Over-current protection:

When the quadcopter's rotating blade is collided or jammed, the control system will stop supplying power for the rotors automatically. Then please re-match the signal for flying.

Gyro trimming function:

In case of flight disorder or sideward flight, restore factory default settings by the following methods:

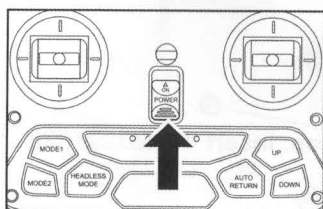

①. Press the power switch to turn on the transmitter.

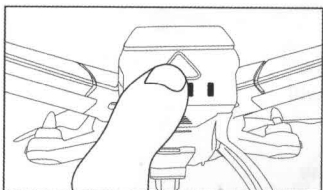

②. Press the power switch to turn on the quadcopter.

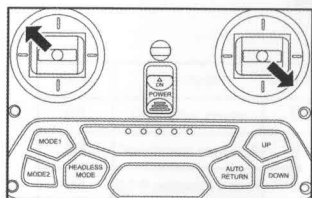

④. Place the quadcopter on a horizontal position, then push the left control stick to the upper left corner and right control stick to the right bottom for about 5 seconds, gyro will be trimmed well while the indicator suddenly quick flash.

SEARCH FOR SIGNALS OF SATELLITE

After trimming the gyro, just put the drone on a horizontal position, and see the indicator light on controller or drone body. While the indicator light on drone body stop flashing and the indicator light on controller start to quick flash, this means the drone already find the signals of satellite.

AUTO BACK HOME FUNCTION

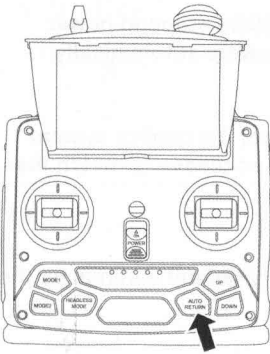

1. When press the Auto back home button, the drone will come back to the controller;
2. When lose the signal of controller, the drone will come back to controller;
3. When the battery of drone is low power, the drone will stay within 30 meters around the controller, when battery is nearly out of power, it will come back to the controller.

PHOTOGRAPHY/VIDEO INSTRUCTIONS:

1. Insert the SD card: Turn the quadcopter power on, insert the SD card to card slot.
2. Get to know how to take photo and video:
 - 1 Take photo: Make sure camera normally work, press the button on the rear left side of the transmitter, camera will take a photo.
 - 2 Take video: Make sure camera normally work, press the button on the rear left side of the transmitter and hold on for 3 seconds then release, camera starts to take videos . Press this button again and hold on for 3 seconds, the camera will stop video work .

TROUBLE SHOOTING

Problem	Reason	Solution
No response from the quadcopter	1. Quadcopter battery power not enough; 2. Transmitter battery power not enough; 3. The band of the transmitter does not correspond to the decoding of the quadcopter.	1. Charge the quadcopter; 2. Charge or replace them if required; 3. Adjust the band on the transmitter and receive it the same as the quadcopter.
If the quadcopter is slow to respond or difficult to maneuver	1. Insufficient power with the transmitter; 2. Transmitter of the same frequency is used nearby.	1. Replace the battery; 2. Use the helicopter out of the range of other RC quadcopter.

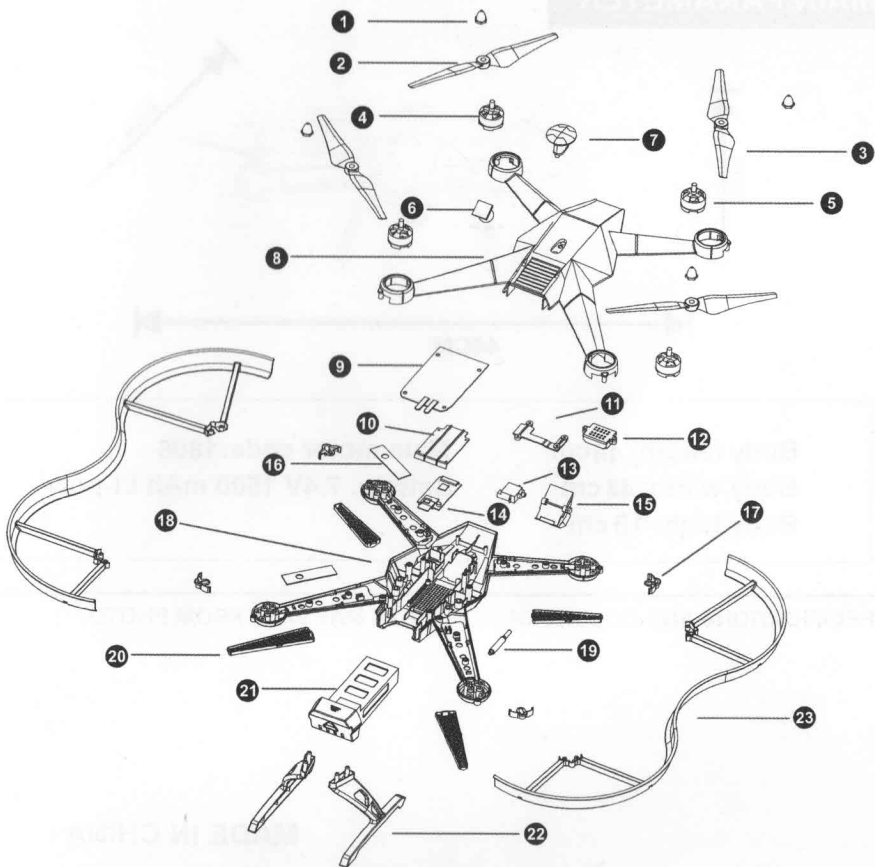

Code	Description	Quantity	Code	Description	Quantity	Code	Description	Quantity
01	Propeller cover	01	02	Propeller A	01	03	Propeller B	01
04	Brushless motor A	01	05	Brushless motor B	01	06	Camera lens	01
07	GPS antenna cover	01	08	Upper body	01	09	Receipt PCB	01
10	Camera lens	01	11	Camera part 1	01	12	Camera part 2	01
13	Servo for camera	01	14	Camera PCB	01	15	Camera part 3	01
16	Electric regulator	01	17	Hole cover	01	18	Lower body	01
19	Antenna	01	20	lampshade	01	21	Battery set	01
22	Landing skid	01	23	Propeller protector	01			

MAIN PARAMETER

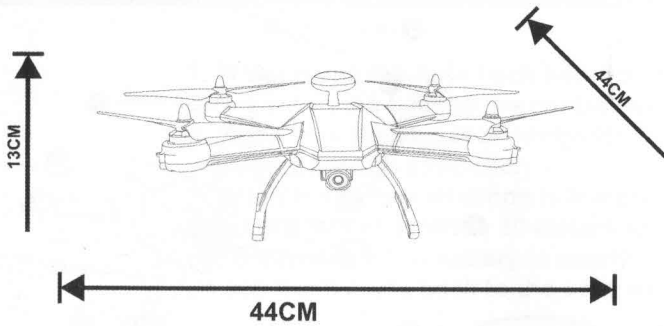

Body length: 44cm
Body width: 44cm
Body high: 13cm

Main motor code: 1806
Battery: 7.4V 1500 mAh Li-poly

SPECIFICATIONS AND COLORS OF CONTENTS MAY VARY FROM PHOTO.

MADE IN CHINA

