

V959  V969

V979  V989  V999  **Super Combo**

4-Axis quadcopter with functions

**INSTRUCTION MANUAL**

**多功能四轴飞行器  
使用说明书**

**Helicopter  
In The House!**

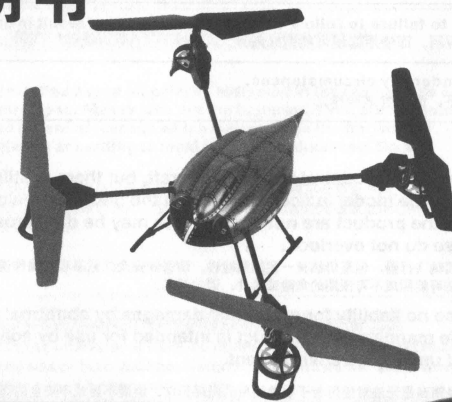

**2.4G**

WLTOYS



Contents	
1	INTRODUCTION 前言
1-2	SAFETY NOTES 安全注意事项
3	PACKAGE ILLUSTRATION 包装说明
3	STANDARD EQUIPMENT 标准配件
3	NOMENCLATURE 飞行器各个部位名称
3	PARTS OF THE INSTALLATION 配件的安装
4	NOMENCLATURE 遥控器各部位名称
5	TRANSMITTER BATTERY INSTALLATION 遥控器电池安装
5	CHARGING BATTERIES 电池的充电
	BATTERY AND CHARGER SPECIFICATION 电池与充电器相关规格
6	BINDING OF RADIO TRANSMITTER AND RECEIVER 遥控器与接收器的对频
6~7	FLIGHT ADJUSTMENT AND SETTING 飞行动作调整与设定
8~9	TROUBLE SHOOTING DURING FLIGHT 如何排除飞行中的状况

Thank you for buying WLTOYS products. The V959 is the latest technology in Rotary RC models. Please read this manual carefully before assembling and flying the new V959 helicopter. We recommend that you keep this manual for future reference regarding tuning and maintenance.

承蒙阁下选用伟力遥控世界系列产品，谨表谢意。进入遥控世界之前必须告诉您许多相关的知识与注意事项，以确保您能够在学习的过程中较得心应手。在开始操作之前，请务必详阅本说明书，相信一定能够给您带来相当大的帮助，也请您妥善保管这本说明书，以作为日后参考。

## 1. INTRODUCTION 前言



Thanks for using witoys products. Helicopter is the first helicopter which can fly outdoor in a wild weather. In order to play Helicopter more convenient and easy, please read it carefully before playing the helicopter. Meanwhile, please keep it well, and take it for reference when adjustment and maintenance.

感谢您选购伟力产品！这是一台能在较小空间及室外飞行的4轴飞行器，为了让您更方便，更容易操控飞行器，请您仔细阅读完此说明书后，再操作这台飞行器，同时请您妥善保管这本说明书，作为日后调整及维修的参考。

flight vehicle can satisfy you whatever rainy or sunny, even when outdoor wild grade 3-4, it will keep moving.

飞行器，无论何时何地，不管晴天雨天，包括室外风力不大于3-4级，都可以满足您对飞行的渴望。

### WARNING LABEL LEGEND 标志代表含义

	<b>WARNING 警告</b> Mishandling due to failure to follow these instructions may result in damage or injury. 因为疏忽这些操作说明，而使用错误可能造成财产损失或严重伤害。
	<b>CAUTION 注意</b> Mishandling due to failure to follow these instructions may result in danger. 因为疏忽这些操作说明，而使用错误可能造成危险。
	<b>FORBIDDEN 禁止</b> Do not attempt under any circumstances. 在任何禁止的环境下，请勿尝试操作。

### IMPORTANT NOTES 重要声明

Helicopter is not a toy, miniature remote control four-axis aircraft, but there is still some risk of the matter with instructions to correctly use the model in accordance with the Security, the dismantling of any modification or improper use of the product are not familiar with may be dangerous to the risk of unexpected or accidental, please do not overlook.

四轴飞行器并非玩具，虽然是小型的遥控四轴飞行器，但是仍然有一定的危险性，请您依安全注意事项与操作说明来正确的使用该模型，任意的改装拆解或使用不当以及产品的不熟悉，都可能造成不可预期的危险或意外，请勿轻视。

Manufacturer and dealer assume no liability for accidental damages by abnormal wear of parts, improper assembly, or operation in unsafe manners. This product is intended for use by age 15 years or older. Please ensure the product is operated under safe environment.

注意！任何遥控飞行器的使用，制造商或经销商是无法对使用者于零件使用的损耗异常，组装不当或不安全的环境操作所发生的意外负任何责任，本产品适用年龄15岁以上，请确保在安全无虞的环境下操作，产品售出后本公司不负责因不当操作/拆卸/改装所引起的财产损失与人身伤害。

We recommend that you seek the assistance or an experienced pilot before attempting to fly our products for the first time. A local expert is the best way to properly assemble, setup, and fly your model for the first time. The requires a certain degree of skill to operate, and is an item subject to normal wear and tear. Any damage or dissatisfaction as a result of accidents or modifications are not covered by any warrantee and cannot be returned for repair or replacement. Please contact our distributors are not covered by any warrantee and cannot be discounted rates when you experience problems during operation or maintenance.

模型商品属于需高操作技术且为消耗性商品，如经拆装使用后，会造成不等到情况零件损耗，任何使用情况所造成商品不良或不满意，将无法于保固条件下更换新品或退货，如遇有使用操作维修问题，本公司全省分公司或代理将提供技术指导，特价零件供应服务。

## 2. SAFETY NOTES 安全注意事项



**CAUTION 注意**  
Fly inly insafe areas away from other people. Do not operate R/C aircraft within the vicinity of crowds or people. R/C aircraft are prone to accidents, failures, and responsible for their actions and damage or injury occurred during pilot error, and radio interference. Pilots are responsible for their actions and damage or injury occurred during the operation or as a result of R/C aircraft models.

遥控模型，四轴飞行器属于危险性商品，飞行时必须远离人群，人为组装不当或机件损坏，电子控制设备不良，以及操控上的不熟悉，都有可能造成飞行失控损伤等不可预期的意外，请飞行者务必注意飞行安全，并需了解自负疏忽所造成任何意外之责任。



**FORBIDDEN 禁止**  
Special despecial design for indoor & outdoor, please keep it away from obstacle  
室内、室外专用机，请远离障碍物

This product is suitable for indoor and outdoor (the wind grade should be no more than 4), please choose a place without obstacle, and keep distance from crowd and pets, don't play it under unsafe, for instance, heat source, wire or electronic power source, in order not to be damaged by collision landing, entanglement and lead to a fire, electric shock and cause losses of lives and property

本产品适合室内、室外（包括室外风力不大于4级）环境飞行的遥控飞行器，飞行时请妥善选择无障碍的室内、室外场地，并与人群或宠物等到保持适当距离，切勿于不安全的环境下操作，如热源、电线、电源等等，以免飞行器碰撞、迫降、纠缠而引起火灾、电击等危险，造成生命财产损失。



### PREVENT MOISTURE 远离潮湿环境

R/C models are composed of many precision electrical components. It is critical to keep the model and associated equipment away from moisture and other contaminants. The introduction or exposure to water or moisture in any form can cause the model to malfunction resulting in malfunction, or a crash. Do not operate or expose to rain or moisture.

飞行器内部也是由许多精密的电子零组件组成，所以必须绝对的防止潮湿或水汽，避免在浴室或雨天时使用，防止水汽进入机身内部而导致机件及电子零件故障而引发不可预期的意外！

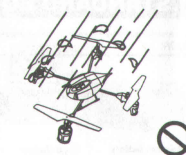

### PROPER OPERATION 勿不当使用本产品

To avoid potential fire hazard from batteries, please do not short, reverse polarity, or puncture batteries. Battery charging must be done under supervision at all times, and at location out of reach by children. Double check the four AA batteries are rechargeable Ni-CD/MH batteries before charging. The manufacturer or this product will not be liable for accidental damages incurred by charging non-rechargeable batteries.

请勿任意拆卸或任意改造加工，任何的升级改装或维修，请使用伟力产品目录的零件，以确保结构的安全。请确认于产品限界内操作，请勿过载使用，并勿用于安全法令外其它非法用途。

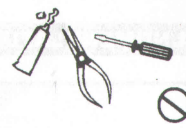

### SAFETY NOTE FOR NI-MH BATTERIES 镍氢电池使用安全

Make sure the batteries are installed based on polarity indicated in the case and do not mix batteries of different chemistry/spec. Please take out the batteries if you are not going to use for a long time to avoid potential leakage which may damage the transmitter. Please dispose depleted batteries according to local laws and ordinances. Do not dispose improperly.

安装时请确认正负极位置，新旧电池请勿同时混用以免影响电池寿命。若长时间不使用本产品，请取出电池，以免造成电池漏液、故障。若电池有漏液状况请勿使用。废弃的电池，请依照该使用国家或地区的废弃物管理法令回收，切勿任意丢弃以免污染环境。



### SAFETY NOTE ON LI-POLYMER BATTERIES 锂聚合物电池使用安全

Li-Polymer batteries poses higher operational risks compared to other battery chemistry, thus it is imperative to follow its usage instructions. Manufacturer and dealer assume no liability for accidental damages caused by improper usage.

Do not use charger other than the factory supplied unit to avoid potential fire and explosion. Do not crush, disassemble, burn, and reverse polarity. Avoid metallic materials to come into contact with battery's polarity and cause it short and never puncture batteries to avoid fire hazards.

Battery charging must be done under supervision at all times, and at location out of reach by children. Please stop the use or charge of the battery should there be an unusual increase in battery temperature after use. Continue use of this battery may cause it to expand, deform, explode, or even result in fire hazards.

Please dispose depleted batteries according to local laws and ordinances. Do not dispose improperly.

锂聚合物电池较其它电池有更高的危险性，使用钱请务必详读并遵照下列注意事项使用本电池，本公司将不对任何不当使用所造成的损害负责。

严禁使用原厂以外的充电器进行充电，以免发生爆炸起火的危险。

严禁撞击、拆解、正负极反接、焚烧电池，避免金属物品碰触电池正负极造成短路。并请防止尖锐的物品刺穿电池，以避免电池起火的危险。

充电时请谨慎小心，确保在您的视线范围内进行充电，并远离幼童可以接触的地方，以免发生危险。

电池使用后如有发热情况，严禁充电。否则会造成电池膨胀、变形、爆炸甚至起火燃烧，危害生命财产的安全。废弃的电池，请严格依照该使用国家或地区的废弃物管理法令回收，以免污染环境。

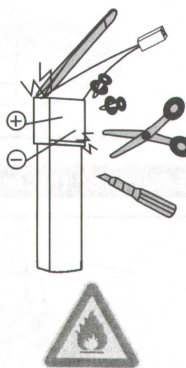

### KEEP AWAY FROM HEAT 远离热源

R/C models are made of various forms or plastic. Plastic is very susceptible to damage or deformation due to extreme heat and cold climate. Make sure not to store the model near any source of heat such as an oven, or heater. It is best to store the model indoors, in a climate-controlled, room temperature environment.

飞行器多半是以PA纤维或聚乙烯，电子商品为主要材料质，因此要尽量远离热源、日晒，以避免因高温而变形甚至溶毁损坏的可能。



### OBTAIN THE ASSISTANCE OF AN EXPERIENCED PILOT 避免独自操控

The products are suitable for more than 15 years old age, at the beginning it will have some certain difficulty in learning, suggestion guidance by experienced when playing.

本产品适用年龄15岁以上，遥控四轴飞行器在学习初期有着一定难度，建议要有经验的人士在旁指导才可以飞行。



### 3. STANDARD EQUIPMENT 标准配件

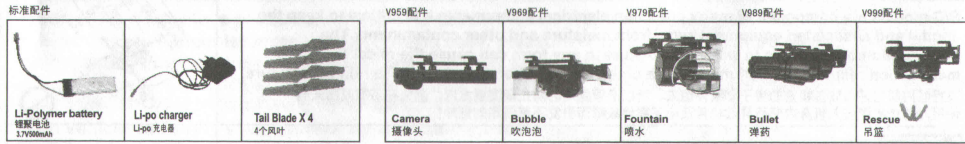

### 4. NOMENCLATURE 飞行器各部位名称

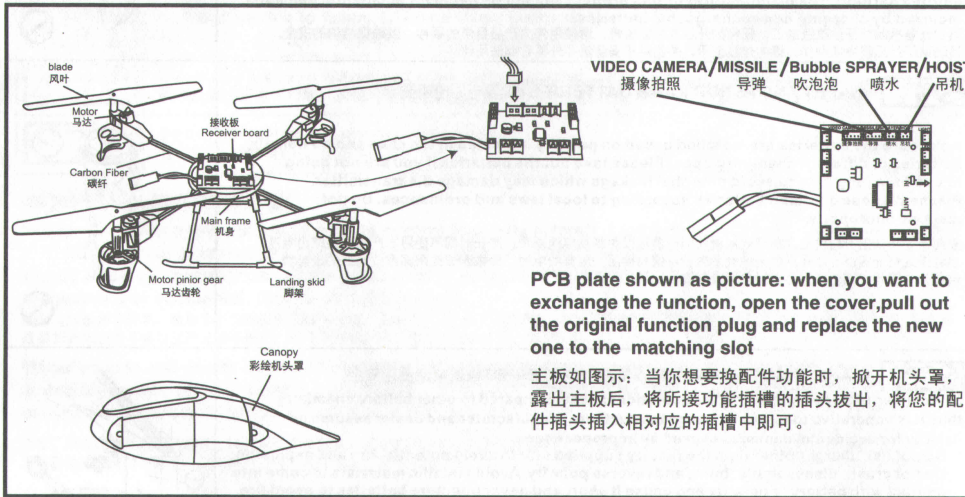

### 5. Parts of the installation 配件的安装

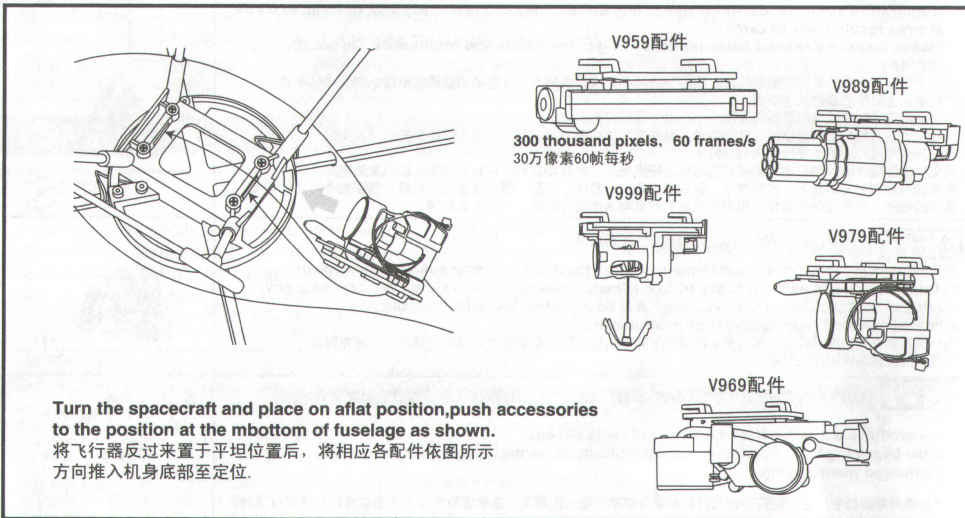

### 5. NOMENCLATURE 遥控器各部位名称

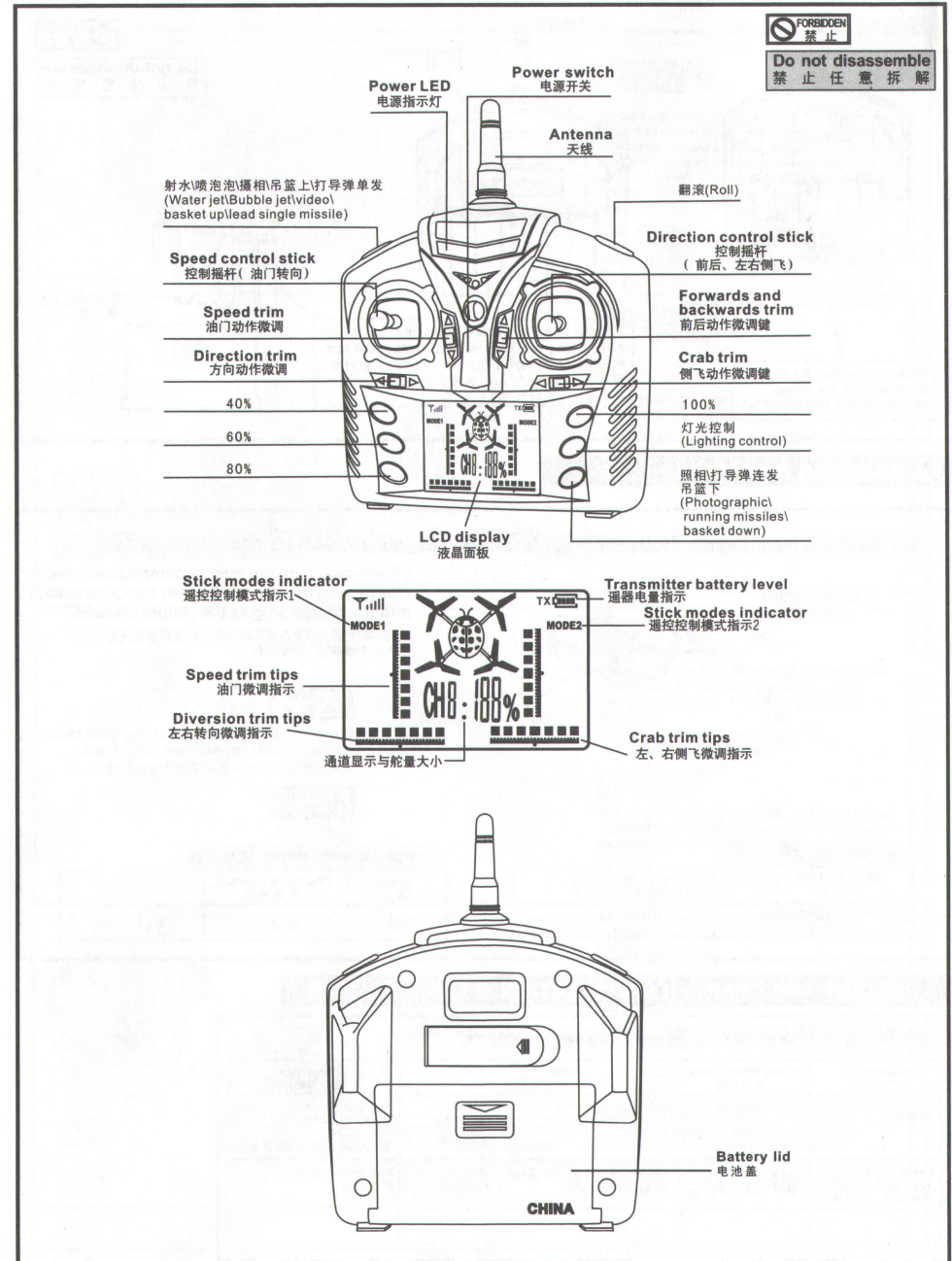

## 6. TRANSMITTER BATTERY INSTALLATION 遥控器电池安装

**Step 1**

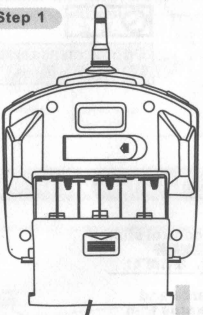

Slide the battery lid to open by following the arrow.  
请依箭头方向先将电池盖打开。

**Step 2**

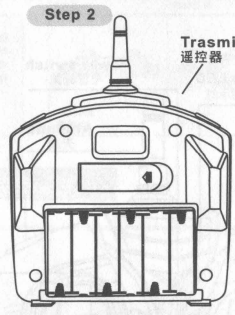

Trasmitter 遥控器

Do not disassemble  
禁止任意拆解

Please use 6 AA sized batteries, installed based on polarity indicated case. Do not mix batteries of different chemistry/spec.  
请使用6颗3号电池(AA),并依正负极性方向组装。(勿混用不同规格电池)

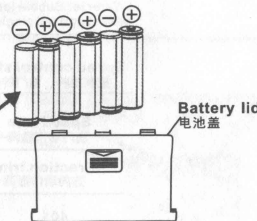

Battery lid 电池盖

## 7. CHARGING BATTERIES 电池的充电

Use the charging line of the controller to charge the helicopter 利用遥控器上的充电器给飞行器电池充电

Please switch on the remote control, insert the charge plug into the E728 insert the Li-po battery into the charge plug as the picture showed.  
用伟力配送的飞碟专用充电器充电。将锂聚电池插头, 插入充电器插口。如图所示

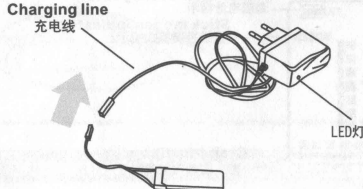

Charging line 充电线

LED灯

锂聚电池 3.7V500mAh

**LED Indicator LED 表示**

green light on 绿灯亮	orange light on 橙色亮
Charge Completion 充电完成	Charging 充电中

**WARNING 警告**  
For safety concerns, battery charging must be done under supervision at all times.  
为确保安全, 充电时务必在视线范围内进行。

**CAUTION 注意**

**Charger Specifications 充电规格**

Input 输入	Charging Current 充电电流	Full Voltage 充电电压
220V	500mA	4.2 ± 0.03V

## 8. BATTERY AND CHARGER SPECIFICATION 电池与充电器相关规格

**Battery usage and charge duration reference 电池使用时间与充电时间参考表**

Battery type 电池种类	Battery Specification 电池规格	Usage Duration 可使用时间	Charge Time 充电所需时间
Li-po battery 锂聚电池	3.7V 500mAh	Helicopter flight time 飞行器飞行时间	Approx. 45 Minutes 10 Minutes (Charging current approx. 0.5A) 约45分钟(充电电流约0.5A)
Carbon-Zinc (Non Rechargeable) 碳锌电池(不可充电)	1.5V (GP 15G R6P)	Transmitter Operation Time 供遥控器开机时间	18 Hours 用18小时
			Non Rechargeable 不可充电

## 9. BINDING OF RADIO TRANSMITTER AND RECEIVER 遥控器与接收器的对频

**Step 1 步骤 1**

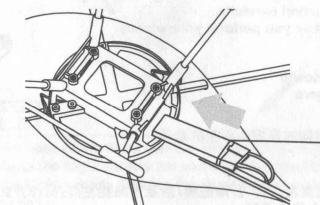

Li-Polymer Battery  
锂聚电池 3.7V500mAh

Aircraft placed in a flat position, the Li-po batteries according to the diagram shown in Direction pushed into the electrical outlet to the positioning of the motherboard light is blinking Do not Then move the body, so that the remote control on the frequency and gyroscope read the neutral point  
将飞行器置于平坦位置后, 将Li-po电池依图所示方向推入电插座至定位, 主板指示灯闪烁此时不要再移动机身, 使遥控器对频与陀螺仪读取中立点。

**Step 2 步骤 2**

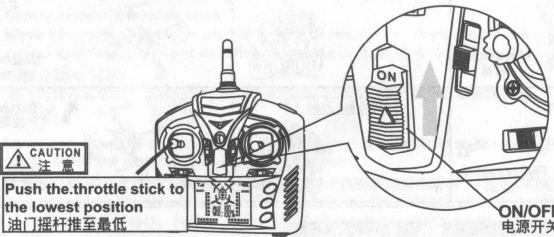

CAUTION 注意  
Push the throttle stick to the lowest position  
油门摇杆推至最低

ON/OFF  
电源开关

The throttle stick to the lowest power on the remote control.  
将油门摇杆推至最低, 打开遥控器电源。

**Step 3 步骤 3**

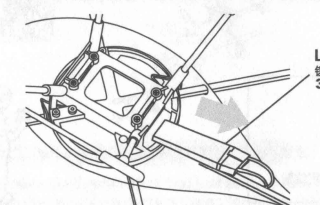

Li-Polymer Battery  
锂聚电池 3.7V500mAh

Remove the flight vehicle battery safely at the conclusion of flight. this should be made into a post flight habit to avoid unforeseeable problems.  
结束飞行时, 请将飞行器电池安全取下, 请养成良好习惯以免造成遗憾。

**WARNING 警告**  
Warning: If left connected in the flight vehicle for long duration, the battery may be damaged due to over-discharge, or even become fire hazards.  
电池未取下, 将导致电池过放电而损坏, 甚至造成起火燃烧的危险。

**Step 4 步骤 4**

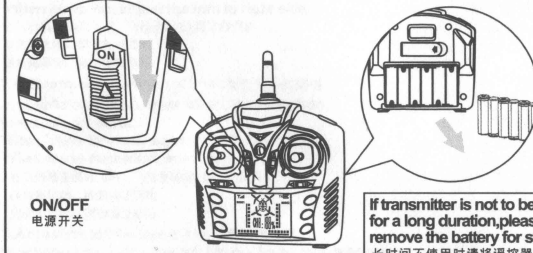

ON/OFF  
电源开关

If transmitter is not to be used for a long duration, please remove the battery for storage.  
长时间不使用时请将遥控器电池取出并妥善保管。

**WARNING 警告**  
Warning: if the AA batteries are left in the transmitter, potential leakage could occur which may damage the transmitter, and create fire hazards.  
电池未取下, 将导致电池漏液而损坏遥控器, 甚至造成起火燃烧的危险。

## 10. FLIGHT ADJUSTMENT AND SETTING 飞行动作调整与设定



### PLEASE PRACTICE SIMULATION FLIGHT BEFORE ACTUAL FLYING 飞行前请先熟练模拟飞行

Before you are familiar with the flight vehicle, please don't set it fly, read the instruction carefully. Get familiar with all kinds of direction control and keep repeating until you can play it as you perform your wishes.

1. Place the flight vehicle a clear open field and the tail of helicopter point to yourself.
2. Practice to operate the throttle stick (as below illustration) and repeat practicing "Throttle high/low", "Aileron left/right", "Rudder left/right", and "Elevator up/down".
3. The simulation flight practice is very important, please keep practicing until the fingers move naturally when you hear operation orders being call out.

在还没有了解飞行器各个动作的操作前, 严禁实机飞行, 请先阅读说明书, 熟悉各种方向的操控并不断的重复, 直到手指可熟练的控制各种动作以及方向。

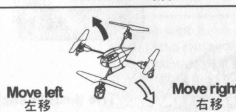
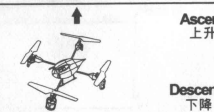
1. 将飞行器在空旷的地方, 并将飞行器背面对准自己。
2. 练习操作遥控器的各摇杆(各动作的操作方式如下图), 并反复练习油门高/低、副翼左/右、升降舵前/后及方向舵左/右操作方式。
3. 模拟飞行的练习相当重要, 请重复练习直到不需要思索, 手指能自然随着喊出的指令移动控制。

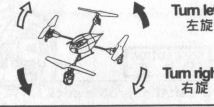
Mode	Illustration 图示	Mode	Illustration 图示
<b>Aileron 副翼</b>		<b>Throttle 油门</b>	
<b>Elevator 升降/前后</b>		<b>Rudder 方向</b>	

### FLIGHT ADJUSTMENT AND NOTICE FOR BEGINNERS 初学飞行调整与注意



- ⊙ Check if the screws are firmly tightened
- ⊙ Check if the transmitter and receivers are fully charged.
- ⊙ 再次确认螺丝是否锁固?
- ⊙ 发射器和接收器电池是否足够。



- ⊙ Make sure that no people or obstructions in the vicinity.
- ⊙ You must first practice hovering for flying safety, this is a basic flight action. (flight vehicle means keeping the helicopter in mid air in a fixed position)
- ⊙ Please stand approximately 2m diagonally behind the helicopter.
- ⊙ 确认临地地区没有人和障碍物。
- ⊙ 为了飞行安全, 你必须先练习停悬, 这是飞行动作的基础(停悬: 飞行器滞留空中并保持固定位置)。
- ⊙ 练习时, 请站在飞行器后方2公尺。

When arriving at the flying field.  
请在没有人及障碍物的空旷室内、室外飞行

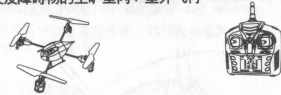

### STEP 1 THROTTLE CONTROL PRACTICE 油门控制练习

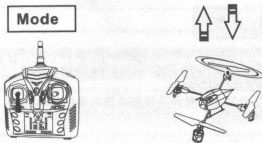

When the flight vehicle begins to lift-off the ground, slowly reduce the throttle to bring the flight vehicle back down. Keep practicing this action until you control the throttle smoothly.

当飞行器离地后, 慢慢降低油门将飞行器降下。持续练习飞行器从地面上升和下降知道你觉得油门控制很顺。

### STEP 2 AILERON AND ELEVATOR CONTROL PRACTICE 副翼和升降控制练习

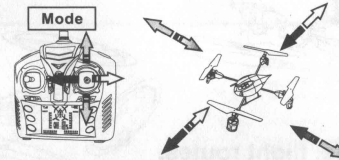

1. 慢慢升起油门摇杆
2. 使飞行器依指示: 移动向后/向前/向左/向右, 慢慢地向后移动副翼和升降摇杆并将飞行器开回原来位置。



- ⊙ If the nose of the flight vehicle moves, please lower the throttle stick and land the flight vehicle. Then move your position diagonally behind the flight vehicle 2m and continue practicing.
- ⊙ If the flight vehicle flies too far away from you, please land the flight vehicle and move your position behind 2m and continue practicing.
- ⊙ 当飞行器偏移时, 请降低油门并且降落, 然后移动到自己的位置到飞行器的正后方2公尺再继续练习。
- ⊙ 假如飞行器离你太远, 请先降飞行器, 并到飞行器后2公尺再继续练习。

### STEP 3 RUDDER CONTROL PRACTICING 方向舵操作练习

1. Slowly raise the throttle stick.
2. Move the nose of the flight vehicle to right or left, and then slowly move the rudder stick in the opposite direction to fly back to its original position.

1. 慢慢升起油门摇杆
2. 将飞行器左右移动, 然后慢慢地向后移动方向舵摇杆并将飞行器飞回原来的位置。

### STEP 4

After you are familiar with all actions from Step 1 to 3, draw a circle on the ground and practice within the circle to increase your accuracy.

当你觉得Step1-3动作熟悉了, 在地上画圈并在这个圈围的范围内练习飞行, 以增加你的操控的准确度。

- ⊙ You can reduce the size of the circle as you become familiarized with the control reflexes.
- ⊙ 当你更加习惯操作动作, 你可以画更小的圆圈。

### STEP 5 DIRECTION CHANGE AND HOVERING PRACTICE 改变直升机方向和练习停悬

After you are familiar with Step 1 to 4, stand at side of the helicopter and continue practicing Step 1 to 4. Then repeat the Step 1 to 4 by standing in front of the helicopter.

当你觉得step1-4动作熟悉了站在面对飞行器侧边并继续练习step1-4. 之后, 站在飞行器前方重复步骤练习。

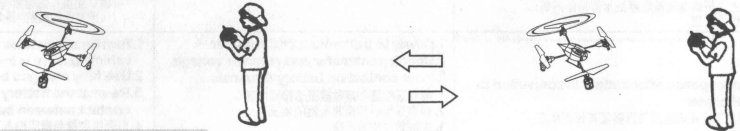

### ADJUSTMENT OF EACH TRIM 飞行动作微调

Slowly raise the throttle stick and just as the helicopter lift-off the ground, you can use the trim to correct the action if the helicopter leans in a different direction. 慢慢升起油门摇杆, 当飞行器刚刚离开地面时, 若飞行器倾向不同方向, 可使用微调修正动作。

1. Adjustment of rudder trim 调整方向舵微调  
Just before the helicopter lift-off, the nose lean left/right...

When leans right, adjust the trim to left side.

When leans left, adjust the trim to right side.

在飞行器正要起飞时, 飞行器朝左/右方向偏移...

向右偏移时, 微调向左调整。

向左偏移时, 微调向右调整。

2. Adjustment of elevator trim 调整升降舵微调  
Just before the helicopter lift-off, the nose lean forward/backward...

When leans forward, adjust the trim to down.

When leans backward, adjust the trim up.

在飞行器正要起飞时, 飞行器朝前/后方向偏移...

向前偏移时, 微调向下调整。

向后偏移时, 微调向上调整。

3. Adjustment of aileron trim 调整副翼微调  
Just before the helicopter lift-off, the body lean left/right...

When leans right, adjust the trim to left side.

When leans left, adjust the trim to right side.

在飞行器正要起飞时, 飞行器朝左/右方向偏移...

向右偏移时, 微调向左调整。

向左偏移时, 微调向右调整。

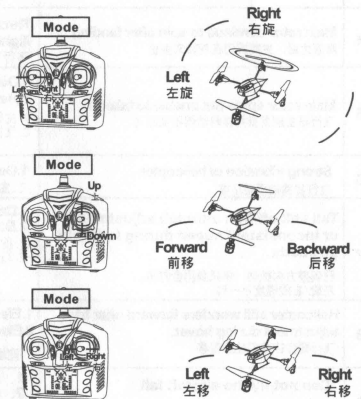



**Stable, flexible, flight routes,  
Drift, 3D to roll easily**  
飞行稳定、灵活、航线、  
甩尾、3D翻滚动作轻松实现

★ The basic movements of the face are very skilled, you can play some of the breathtaking tumbling action. First remote control of the rudder to 100%, then the LCD backlight turns orange. Four-axis aircraft flew more than threeheight. Wdd the button at the top-right corner, push forward and backward, left or right side of the fly joystick to the end and then release, then the vehicle can roll over.

★ 当前面的基本动作都很熟练时就可以玩一些惊险的翻滚动作。首先遥控器的舵量调到100%，将四轴飞行器飞到3米以上高度后，按住遥控器右上角按键然后 把前进后退或左右侧飞摇杆打到底然后松开，此时飞行器就可以翻滚过来。

### 11.TROUBLE SHOOTING DURING FLIGHT 如何排除飞行中的状况



	Situation 状况	Cause 原因	Way to deal 对策
1	Receiver status LED blinks continuously for more than 4 seconds after helicopter battery inserted. No response to control input. 插上飞行器电池接收器指示灯持续闪烁，操作无反应	Unable to bind to transmitter. 遥控器与接收器未对频成功	Repeat the power up Initializing process. (Refer to P.8:Binding of radio transmitter and receiver) 请重新执行遥控器与接收板的对频动作 (请参阅P.8遥控器与接收器的对频)
2	No response after battery is connected to helicopter. 插上飞行器电池后飞行器没有任何反应	1.power to transmitter and receiver. 2.Check transmitter and receiver voltage. 3.Poor contact on battery terminals. 1. 检查遥控器和接收器是否接通电源 2. 检查遥控器和接收电池的电压 3. 电池极片接触不良	1.Turn on transmitter and ensure flight vehicle battery is inserted properly. 2.Use fully charged batteries. 3.Re-seat the battery and ensure good contact between battery contacts. 1. 打开发射器与确实插入飞行器电池至定位 2. 使用完全充电的电池 3. 重新插入电池，确认电池和电池极片的接触是否正常
3	Motor does not respond to throttle stick, receiver LED flashes. 推动油门摇杆时马达不转，且接收器指示灯开始闪烁。	Helicopter battery depleted. 飞行器锂电池电量不足	Fully charge the battery, or replace with a fully charged battery. 将电池充电或更换另一个充电的电池
4	Main rotor continue to spin after landing 降落之后，主旋翼仍在旋转未停止	Throttle trim accidentally increased during flight. 飞行中误将油门微调调高	Confirm throttle trim is in center or slightly below. 确认油门微调在中间位置或是稍微向下调
5	Main rotor spins but unable to takeoff. 飞行器主旋翼有持续转动但不能起飞	1.Deformed main blades. 2.Helicopter battery depleted 1. 主旋翼变形 2. 飞行器电池电量不足	1.Replace main blades 2.Charge or replace with a fully charged battery. 1. 更换主旋翼 2. 将电池充电或是更换另一个充电的电池
6	Strong vibration of helicopter 飞行器震动得很厉害	1.Deformed main blades 1. 主旋翼变形	1.Replace main blades 1. 更换主旋翼
7	Tail still off trim after tab adjustment, or inconsistent speed during left/right prouette. 已调整方向微调，但机身仍会打转，左旋/右旋速度不一致	1.Damaged tail rotors 2.Damaged tail drive motor 1. 旋翼变形 2. 马达不良	Replacement of the main wing Replace the main motor 更换主翼 更换主马达
8	Helicopter still wonders forward after trim adjustment during hover. 飞行器会往前或往后偏移	1.Elevator servo not level during power up. 2.Elevator pushrod too long or too short. 陀螺仪中点不对。	The boot will lift fine-tune the normalized neutral point, the new boot. 开机后将升降微调归中立点，从新开机。
9	Can not fly the aircraft fall 飞行器跌落飞不起来	1. motor fall out 2. gear loosen 1. 电机脱落 2. 齿轮松动	1. install the motor again 2. tighten the gear 1. 从新装回电机 2. 把齿轮装紧

### 12.PARTS LIST 各种零件名称

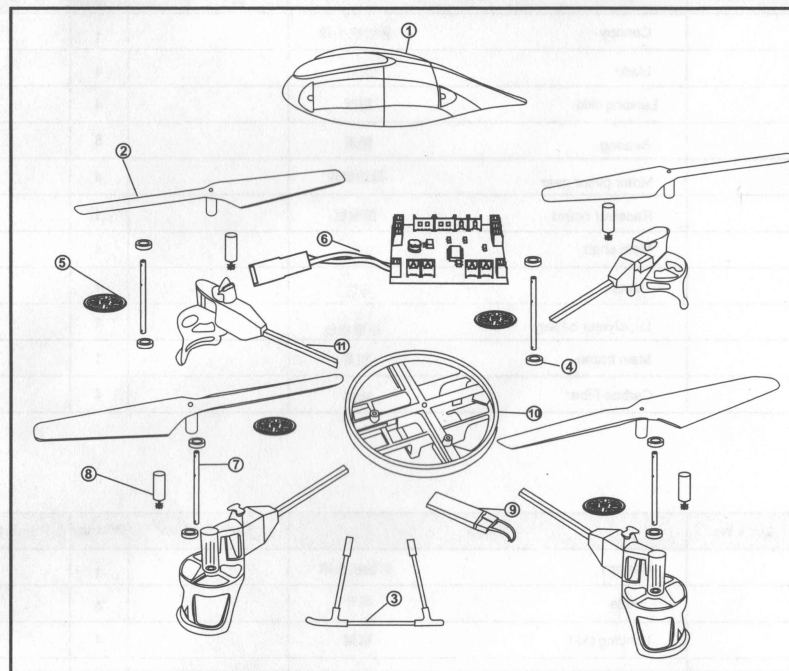

No.	Code No.	Name	Specification	Quantity	Remarks
1		Canopy	彩绘机头罩	1	
2		blade	风叶	4	
3		Landing skid	脚架	4	
4		Bearing	轴承	8	
5		Motor pinion gear	马达齿轮	4	
6		Receiver board	接收板	1	
7		Main shaft	主轴	4	
8		Motor	马达	4	
9		Li-polymer battery	锂聚电池	1	
10		Main frame	机身	1	
11		Carbon Fiber	碳纤	4	

No.	Code No.	Name	Specification	Quantity	Remarks
1		Canopy	彩绘机头罩	1	
2		Blade	风叶	4	
3		Landing skid	脚架	4	
4		Motor	马达	4	
5		Receiver board	接收板	1	
6		Main frame	机身	1	
7		Li-polymer battery	锂聚电池	1	
8		Carbon Fiber	碳纤	4	

Specifications ,contents of parts and avsilability are subject to change,Align RC is not responsible for inadvertent errors in this publication.

本说明书内的材质，规格或零件包装之内物谨供参考。本公司将不对此印刷物之异动负责也无法主动通知消费者，任何更新或异动，请以伟力网页为主。

V959□ V969□  
V979□ V989□ V999□ **Super Combo**

# 4-Axis quadcopter with functions INSTRUCTION MANUAL 多功能四轴飞行器 使用说明书

Helicopter  
In The House!

2.4G  
WLTOYS

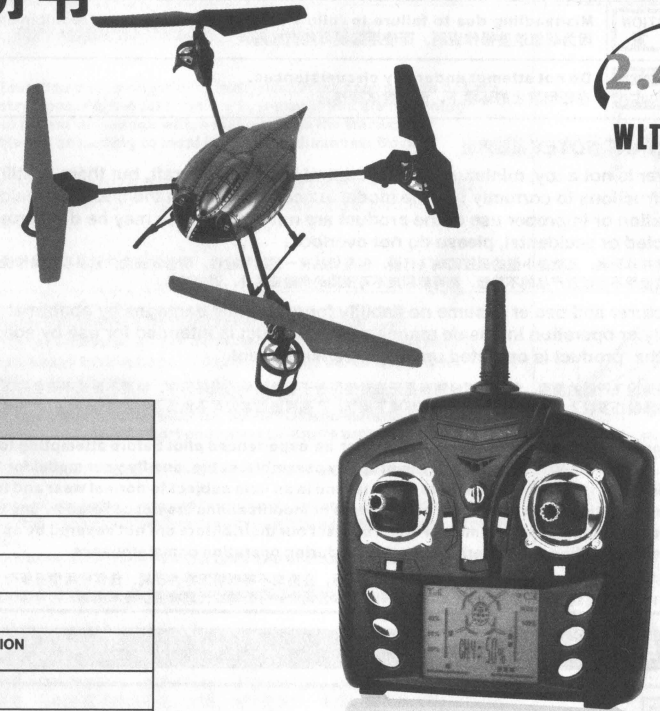

## Contents

1	INTRODUCTION 前言
1-2	SAFETY NOTES 安全注意事项
3	PACKAGE ILLUSTRATION 包装说明
3	STANDARD EQUIPMENT 标准配件
3	NOMENCLATURE 飞行器各个部位名称
3	PARTS OF THE INSTALLATION 配件的安装
4	NOMENCLATURE 遥控器各部位名称
5	TRANSMITTER BATTERY INSTALLATION 遥控器电池安装
5	CHARGING BATTERIES 电池的充电 BATTERY AND CHARGER SPECIFICATION 电池与充电器相关规格
6	BINDING OF RADIO TRANSMITTER AND RECEIVER 遥控器与接收器对频
6-7	FLIGHT ADJUSTMENT AND SETTING 飞行动作调整与设定
8-9	TROUBLE SHOOTING DURING FLIGHT 如何排除飞行中的状况

Thank you for buying WLTOYS products. The V959 is the latest technology in Rotary RC models. Please read this manual carefully before assembling and flying the new V959 helicopter. We recommend that you keep this manual for future reference regarding tuning and maintenance.

承蒙阁下选用伟力遥控世界系列产品，谨表谢意。进入遥控世界之前必须告诉您许多相关的知识与注意事项，以确保您能够在学习的过程中得心应手。在开始操作之前，请务必详阅本说明书，相信一定能够给您带来相当大的帮助，也请您妥善保管这本说明书，以作为日后参考。