



RADIOLINK AT10

10-CHANNEL RADIO CONTROL SYSTEM

INSTRUCTION MANUAL



Technical updates and additional programming examples available at: <http://www.radiolink.com.cn>



TABLE OF CONTENTS

<p>INTRODUCTION 3</p> <p style="padding-left: 20px;">Additional Technical Help, Support and Service 3</p> <p style="padding-left: 20px;">Safety Precautions (do not operate without reading) .. 4</p> <p style="padding-left: 20px;">Introduction to the AT10..... 5</p> <p style="padding-left: 20px;">Transmitter Controls & Switch Identification/Assignments 6</p> <p style="padding-left: 20px;">Stick Adjustments 10</p> <p style="padding-left: 20px;">Adjusting display contrast 11</p> <p style="padding-left: 20px;">Changing mode..... 11</p> <p style="padding-left: 20px;">Radio Installation & Range Checking 11</p> <p style="padding-left: 20px;">Transmitter Displays and Buttons 15</p> <p> </p> <p>AIRPLANE (ACRO) FUNCTIONS 16</p> <p style="padding-left: 20px;">Map of Functions..... 17</p> <p style="padding-left: 20px;">Quick Guide to Setting up a 4-channel Airplane 18</p> <p>ACRO BASIC MENU FUNCTIONS 20</p> <p style="padding-left: 20px;">MODEL Submenu: MODEL SELECT, COPY, NAME 20</p> <p style="padding-left: 20px;">PARAMETER Submenu: RESET, TYPE, MODUL, ATL, AILE-2, CONTRAST, BACK-LIGHT, HOME-DISP, USER NAME 23</p> <p style="padding-left: 20px;">LOGIC SW 26</p> <p style="padding-left: 20px;">Servo REVERSE 26</p> <p style="padding-left: 20px;">END POINT 27</p> <p style="padding-left: 20px;">Idle Management: IDLE DOWN and THR-CUT 28</p> <p style="padding-left: 20px;">Dual/Triple Rates and Exponential (D/R, EXP)..... 30</p> <p style="padding-left: 20px;">TIMER Submenu..... 33</p> <p style="padding-left: 20px;">Auxiliary Channel assignments and CH9 reverse (AUX-CH) 34</p> <p style="padding-left: 20px;">TRAINER 34</p> <p style="padding-left: 20px;">TRIM and SUB-TRIM 35</p> <p style="padding-left: 20px;">SERVO Display 37</p> <p style="padding-left: 20px;">Fail Safe and Battery FailSafe (F/S)..... 37</p> <p>ACRO ADVANCE MENU FUNCTIONS 38</p> <p style="padding-left: 20px;">Wing types 39</p> <p style="padding-left: 20px;">FLAPERON 39</p> <p style="padding-left: 20px;">FLAP TRIM 40</p> <p style="padding-left: 20px;">Aileron Differential (AILE-DIFF)..... 41</p> <p style="padding-left: 20px;">Using a 5-channel receiver: AILE-2 42</p> <p style="padding-left: 20px;">ELEVON (see tail types) 43</p> <p style="padding-left: 20px;">Tail types 43</p> <p style="padding-left: 20px;">ELEVON 43</p> <p style="padding-left: 20px;">Twin Elevator Servos (AILEVATOR)..... 44</p> <p style="padding-left: 20px;">V-TAIL 45</p> <p style="padding-left: 20px;">SNAP ROLL 45</p> <p style="padding-left: 20px;">Mixes: definitions and types 47</p> <p style="padding-left: 20px;">ELEV-FLAP 48</p> <p style="padding-left: 20px;">AIRBRAKE/BUTTERFLY (crow) 48</p> <p style="padding-left: 20px;">THROTTLE-NEEDLE..... 50</p> <p style="padding-left: 20px;">THROTTLE DELAY 51</p> <p style="padding-left: 20px;">THROTTLE CURVE 52</p>	<p>Linear, Prog. mixes 1-4 53</p> <p>Curve, Prog. mixes 5-8 55</p> <p>GYA gyro mixing (GYRO SENSE)..... 56</p> <p> </p> <p>GLIDER (GLID(1A+1F)/(2A+1F)/(2A+2F)) FUNCTIONS . 58</p> <p style="padding-left: 20px;">Table of contents..... 58</p> <p style="padding-left: 20px;">Getting Started with a Basic 4-CH Glider 59</p> <p>GLIDER-SPECIFIC BASIC MENU FUNCTIONS 61</p> <p style="padding-left: 20px;">Model type (PARAMETER submenu) 61</p> <p style="padding-left: 20px;">MOTOR CUT 62</p> <p>GLIDER-SPECIFIC ADVANCE MENU FUNCTIONS 62</p> <p style="padding-left: 20px;">AILE/RUDD 63</p> <p style="padding-left: 20px;">AILE-FLAP (GLID(2A+2F) only) 64</p> <p style="padding-left: 20px;">SPOILER MIX 64</p> <p style="padding-left: 20px;">OFFSETS (Additional flight conditions) 65</p> <p style="padding-left: 20px;">START DELAY (GLID(1A+1F) only)..... 66</p> <p style="padding-left: 20px;">CAMBER MIX 67</p> <p style="padding-left: 20px;">CAMBER FLAP 67</p> <p style="padding-left: 20px;">BUTTERFLY 68</p> <p style="padding-left: 20px;">Channel 3's function selection (CONDITION/FUNCTION) 69</p> <p> </p> <p>HELICOPTER FUNCTIONS..... 70</p> <p style="padding-left: 20px;">Table of contents and reference info for helicopters . 70</p> <p style="padding-left: 20px;">Getting Started with a Basic Helicopter 71</p> <p>HELL-SPECIFIC BASIC MENU FUNCTIONS 73</p> <p style="padding-left: 20px;">MODEL TYPE (PARAMETERS submenu) 74</p> <p style="padding-left: 20px;">SWASH AFR (swashplate surface direction and travel correction) (not in H-1)..... 75</p> <p style="padding-left: 20px;">THROTTLE MIX 76</p> <p style="padding-left: 20px;">Setting up the Normal Flight Condition 77</p> <p style="padding-left: 20px;">THR-CUT (specialized settings for helicopter specific models)..... 78</p> <p>HELL-SPECIFIC ADVANCE MENU FUNCTIONS 79</p> <p style="padding-left: 20px;">THROTTLE HOLD 79</p> <p style="padding-left: 20px;">THR-CURVE, PIT-CURVE and REVO 80</p> <p style="padding-left: 40px;">Idle-ups..... 81</p> <p style="padding-left: 40px;">Trims/offset 82</p> <p style="padding-left: 40px;">Delay..... 82</p> <p style="padding-left: 40px;">Hovering setups 83</p> <p style="padding-left: 40px;">High/low pitch 84</p> <p style="padding-left: 40px;">Gyros and governors 85</p> <p>Postback and Monitor real time flight message..... 89</p> <p>Technical Parameter 92</p>
--	--

Note that in the text of this manual, beginning at this point, any time we are using a feature's specialized name or abbreviation, as seen on the screen of the AT10, that name, feature, or abbreviation will be exactly as seen on the radio's screen, including capitalization and shown in a **DIFFERENT TYPE STYLE** for clarity. Any time we mention a specific control on the radio itself, such as moving **SWITCH A**, **KNOB VR(B)**, or the **THROTTLE STICK**, those words will be displayed as they are here.

INTRODUCTION

Thank you for purchasing Radiolink 2.4 GHz 10CH remote control system AT10.

This system is extremely versatile, it is the most complete remote control device as so far in our product series, it can operate helicopter, fixed-wing glider, aircraft all four models. communication system adopts anti-interference strongest DSSS (direct sequence spread spectrum system). Despite the powerful function, humanized menu design applicable to both beginners and skilled person. In order to better use remote control equipment and ensure flight safety, please read the instructions carefully, when we write the instruction to use the familiar and simple words to make it easy for beginners to understand the name and formulation.

Suggestion: when you read this manual, please open the remote control and receiver and connect the receiver steering gear and other related equipment, operating while reading. When you read get some difficulties, please refer to the manual or call our after-service +86-755-88361717 and login BBS (such as www.rcgroups.com, <http://www.5imx.com>, <http://www.rcfans.com>) to check the issues related answer to questions.

Due to unforeseen changes in production procedures, the information contained in this manual is subject to change without notice.

more information please check our website as below:

<http://www.radiolink.com.cn>

CUSTOMER SERVICE

Contact Us

Tel: +86-755-88361717

Fax: +86-755-88360925

Email: sales@radiolink.com.cn

Programming and User questions

Tel: +86-755-88361717

Fax: +86-755-88360925

Email: after_service@radiolink.com.cn

Note: About flying

- ❗ **While you are getting ready to fly, if you place your transmitter on the ground, be sure that the wind won't tip it over. If it is knocked over,** the throttle stick may be accidentally moved, causing the engine to speed up. Also, damage to your transmitter may occur.
- ❗ Other than 2.4GHz system: **Before taxiing, be sure to extend the transmitter antenna to its full length.** collapsed antenna will reduce your flying range and cause a loss of control. It is a good idea to avoid pointing the transmitter antenna directly at the model, since the signal is weakest in that direction.
- ❗ In order to maintain complete control of your aircraft it is important that **it remains visible at all times**. Flying behind large objects such as buildings, grain bins, etc. is not suggested. Doing so may result in the reduction of the quality of the radio frequency link to the model.
- ⊘ 2.4GHz system: **Do not grasp the transmitter module's antenna during flight.** Doing so may degrade the quality of the radio frequency transmission.
- ❗ 2.4GHz system: As with all radio frequency transmissions, the strongest area of signal transmission is from the sides of the 10CH transmitter module's antenna. As such, the antenna should not be pointed directly at the model. If your flying style creates this situation, easily move the antenna to correct this situation.
- ⊘ **Don't fly in the rain!** Water or moisture may enter the transmitter through the antenna or stick openings and cause erratic operation or loss of control. If you must fly in wet weather during a contest, be sure to cover your transmitter with a plastic bag or waterproof barrier. Never fly if lightning is expected.

WARNING:

Any changes or modifications not expressly approved by the party responsible for compliance could void the user's authority to operate the equipment.

FCC Compliance Statement This device complies with part 15 of the FCC rules. Operation is subject to the following two conditions: (1) this device may not cause harmful interference, and (2) this device must accept any interference received, including interference that may cause undesired operation.

Exposure to Radio Frequency Energy

AT10 is radio transmitters. When on, it sends radio frequency (RF) energy through its antenna. The Wireless antenna is located on the top of the device, see the EUT photo for more details. AT10 has been tested and meets the SAR(Specific Absorption Rate) exposure requirements for transmitting.

AT10 is designed and manufactured to comply with the limits for exposure to RF energy set by the Federal Communications Commission (FCC) of the United State. The exposure standard employs a unit of measurement known as the specific absorption rate, or SAR. The SAR limit applicable to A10 set by the FCC is 1.6 watts per kilogram (W/kg). Tests for SAR are conducted using standard operating positions specified by these agencies, with AT10 transmitting at its highest certified power level in all tested frequency bands. Although SAR is determined at the highest certified power level in each frequency band.

AT10 has been tested, and meets the FCC RF exposure guidelines for transmitting. When tested at direct body contact, A10's maximum SAR value for each frequency band is outlined below: 0.011 W/kg 1g Body SAR

A QUICK INTRODUCTION TO THE AT10 SYSTEM

Note that in the text of this manual, beginning at this point, any time we are using a feature's specialized name or abbreviation as seen on the screen of the AT10, that name, feature, or abbreviation will be exactly as seen on the radio's screen, including capitalization and shown in a **DIFFERENT TYPE STYLE** for clarity. Any time we mention a specific control on the radio itself, such as moving *SWITCH A*, *KNOB VR(B)*, or the *THROTTLE STICK*, those words will be displayed as they are here.

TRANSMITTER:

- Large graphic liquid-crystal display panel with 2 buttons, a cursor lever and a turn-and-press Dial for quick, easy setup.
- All transmitters include all 3 aircraft types with specialized programming for each, including:
 - Airplane (**ACRO**)
 - **V-TAIL**
 - **ELEVON**
 - **AIRBRAKE**
 - Twin Aileron Servos (**FLAPERON** and **AIL-DIFF**)
 - Twin Elevator Servos (**AILEVATOR**)
 - Snap Roll (4 separate directions available)
 - Gyro Mixing
 - Helicopter (8 swashplate types, including CCPM, see page 93)(**HELI**)
 - 3 Idle Ups
 - Revo. Mixing
 - Delay
 - Throttle and Pitch Curves per Condition
 - Gyro Mixing including Separate Settings per Condition
 - Governor Mixing
 - Sailplane/Glider (3 wing types)(**GLID 1AIL+1FLP/2AIL+1FLP/2AIL+2FLP**)
 - **V-TAIL**
 - **ELEVON**
 - **OFFSET** (5 conditions)
 - Twin Ailerons (**FLAPERON** and **AIL-DIFF**)
 - Crow (**BUTTERFLY**)
 - 5 Flight Conditions (Normal/Start/Speed/Distance/Landing)
- **BASIC** menu for quick, easy set up of less complex models.
- **ADVANCE** menu for more complex, unique setups.
- Four electronic **TRIM LEVERS** for rapid yet precise trim adjustment - no remembering to “store trims” between models and no more “bumped trims” during transport.
- **IDLE-DOWN (ACRO)**, **THR-CUT (ACRO/HELI)** (engine shut off), and **MOTOR CUT (GLID)** setups to allow precise engine/motor control for taxi and landings.
- New stick design with improved feel, adjustable length and tension.
- Triple rates available by setting dual rates to 3-position switches.
- Eight **SWITCHES**, 3 **DIALS** and 2 **SLIDERS**; completely assignable in most applications.
- Trainer system includes the “functional” (**FUNC**) setting, which allows the student to use the AT10's mixing, helicopter, and other programming functions even with a 4-channel buddy box.
- AT10 transmitter features airplane friendly switch layout, with the trainer switch at the left hand (Mode 2), and a notched throttle to minimize throttle changes with rudder input. Defaults to **ACRO** model type.
- AT10 transmitter features helicopter-friendly switch layout, with idle-up and throttle hold switches at the left hand, and a smooth, ratchet-less (unsprung) throttle for perfect hovering. Defaults to **HELI(H-1** swashplate type) model type.
- Change transmitter mode from mode 2 to modes 1, 3, or 4. (See P. 17)

TRANSMITTER CONTROLS - AIRPLANE

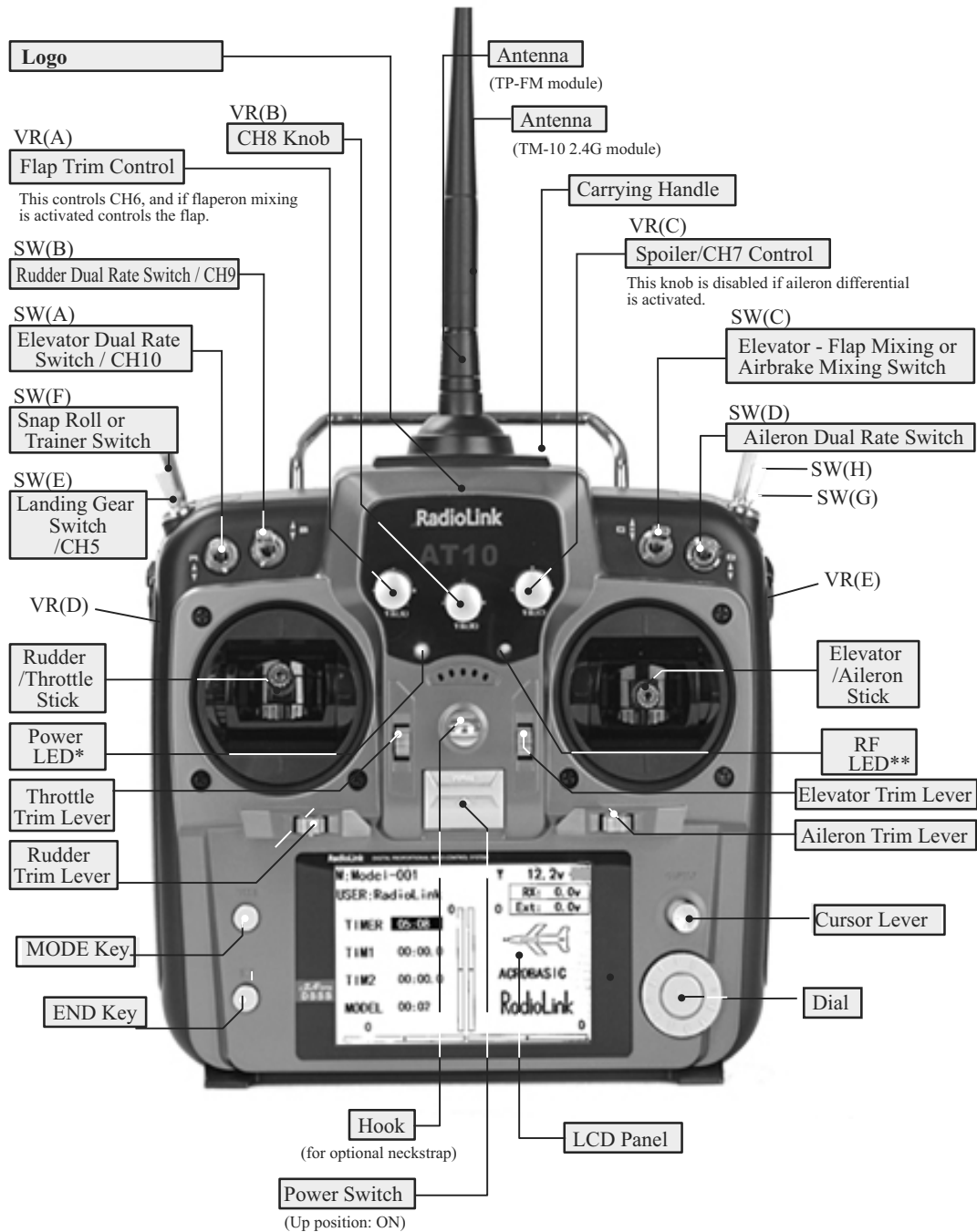

This figure shows the default switch assignments for a AT10 Mode 2 system as supplied by the factory.

You can change many of the switch positions or functions by selecting a new position within the setting menu for the function you wish to move. (Example: move aileron dual rates to switch C to create triple rates.)

* Power LED blinks to indicate if any mix switches are activated.

** RF LED is green when the transmission link is solid and the radio is transmitting properly.

TRANSMITTER CONTROLS - HELI

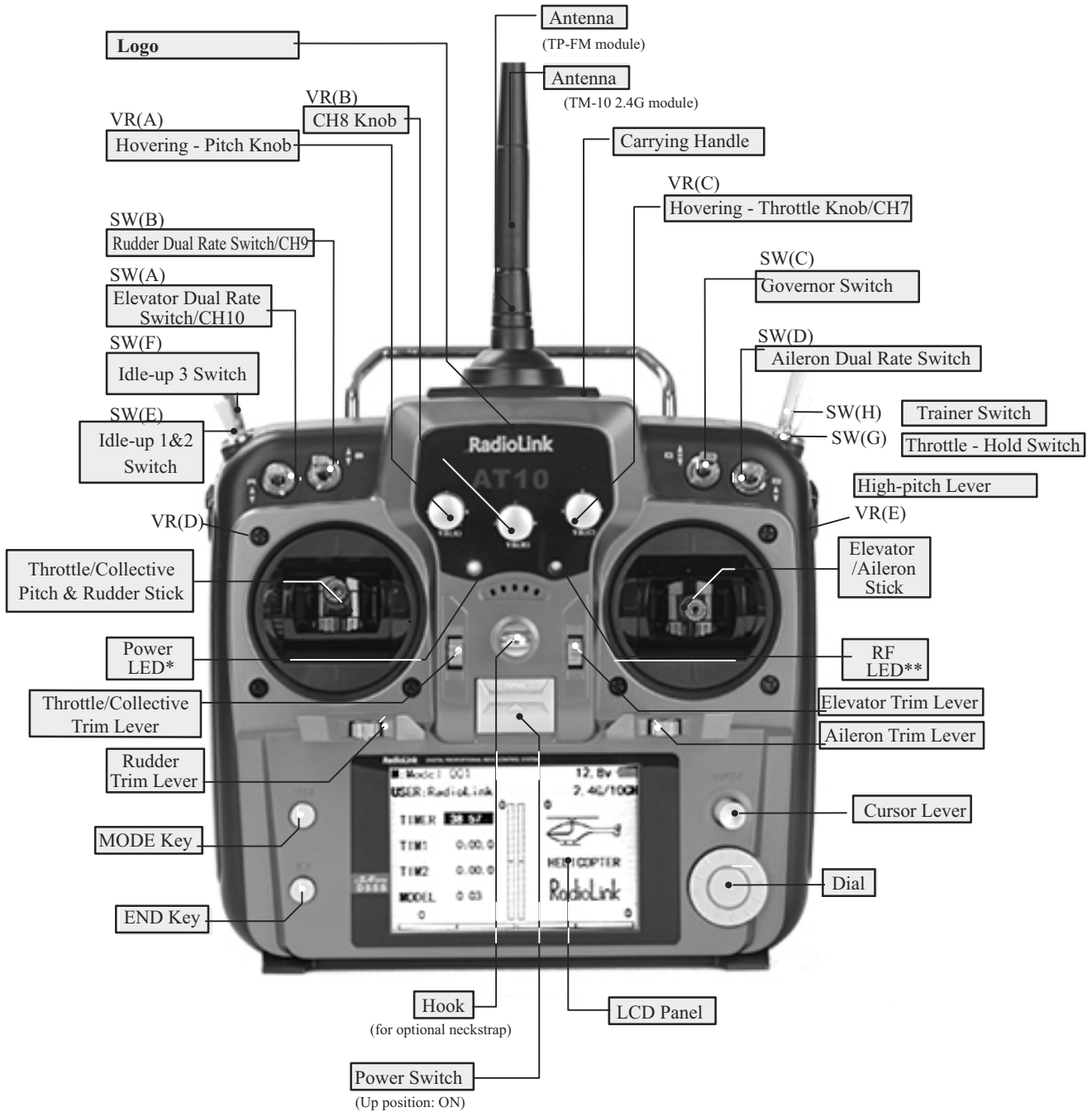

This figure shows the default switch assignments for a AT10 Mode 2 system as supplied by the factory.

You can change many of the switch positions or functions by selecting a new position within the setting menu for the function you wish to move. (Example: move aileron dual rates to switch C to create triple rates.)

* Power LED blinks to indicate if any mix switches are activated.

** RF LED is green when the transmission link is solid and the radio is transmitting properly.

SWITCH ASSIGNMENT TABLE

- The factory default functions activated by the switches and knobs for a AT10 Mode 2 transmitter are shown below.
- Most AT10 functions may be reassigned to non-default positions quickly and easily.
- Basic control assignments of channels 5-10 are quickly adjustable in **AUX-CH** (see p. 46). For example, the channel 5 servo, which defaults to **SWITCH E** for retract use, can easily be unassigned (NULL) to allow for easy use as a second rudder servo in a mix, or to a slider or dial for bomb door or other control.
- Note that most functions need to be activated in the programming to operate.
- AT10 Mode 1, transmitter functions are similar but reverse certain switch commands. Always check that you have the desired switch assignment for each function during set up.

Switch/Knob A or H	Airplane (ACRO)	Sailplane/Glider (GLID)	Helicopter (HELI)
SWITCH A	elevator dual rate ch10	elevator dual rate down = butterfly on ch10	elevator dual rate ch10
SWITCH B	rudder dual rate ch9	rudder dual rate ch9	rudder dual rate ch9
SWITCH C	up = ELE-FLP on center/down = IDLE-DOWN down = AIRBRAKE on	up = ELE-FLP on center = Distance cond. down = Landing cond.	governor
SWITCH D	aileron dual rate	aileron dual rate	aileron dual rate
SWITCH E or G*	landing gear/ch 5		throttle hold/ch5
SWITCH F or H*	snap roll/trainer	trainer	trainer/ THR-CUT
SWITCH G or E*	none	up = Speed cond. down = Start cond.	idle-up 1 and 2
SWITCH H or F*	none		idle-up3/gyro
KNOB A	flap/ch 6 (flap trim if FLAPERON on)	flap ch6	HOVERING PITCH
KNOB B	ch 8	ch 8	ch 8
KNOB C	spoiler/ch 7 (disabled if AIL-DIFF on)	ch 7 (disabled if AIL-DIF on)	HOVERING THROTTLE ch7
SLIDER D	none	ch 5	none
SLIDER E	none	none	HI-PIT

*On the AT10 Mode 2 transmitters, the TOP LEFT **SWITCHES** are spring-loaded and 2-position; on the AT10 Mode 1, those switches are on the right side. For consistency, the switch position's designation remains the same (upper left is F, etc), but the functions are moved to match the switch type.

RECEIVER AND SERVO CONNECTIONS

Receiver Output and Channel	Aircraft (ACRO)
1	aileron/aileron-1 ¹ /combined flap-2 & aileron-1 ²
2	elevator
3	throttle
4	rudder
5	spare/landing gear/aileron-2 ^{1,3} /combined flap-1 and aileron-2 ^{2,3}
6	spare/ flap(s)/combined flap-1 and aileron-2 ²
7	spare/aileron-2 ¹
8	spare/elevator-2 ⁴ /mixture control
9	spare
10	spare

¹ Aileron Differential mode (**AILE-DIFF**). (See p. 54).

² Flaperon mode. (See p. 52).

³ Using Second Aileron option, second aileron servo output is sent to channels 5 and 6 to allow use of a 5-channel receiver. (**AILE-2**) (See p. 55)

⁴ **AILEVATOR** (dual elevator) mode. (See p. 57).

(Wing Type)

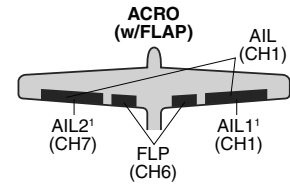
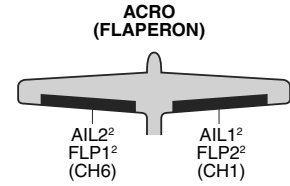

(Tail Type)

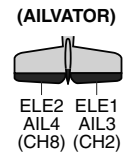

Receiver Output and Channel	Sailplane/Glider (GLID)			
	GLID (1A+1F)		GLID (2A+1F) (AILE-DIFF)	GLID (2A+2F) (AILE-DIFF)
	ELEVON	FLAPERON		
1	combined elevator-2 & aileron-1	combined flap-2 & aileron-1	aileron-1	aileron-1
2	combined elevator-1 & aileron-2	elevator/combined rudder-2 & elevator-1 ²	elevator/combined rudder-2 & elevator-1 ²	elevator/combined rudder-2 & elevator-1 ²
3	spare/motor	spare/motor	spare/motor	spare/motor/spoiler-2 ¹
4	rudder	rudder/combined rudder-1 & elevator-2 ²	rudder/combined rudder-1 & elevator-2 ²	rudder/combined rudder-1 & elevator-2 ²
5	spare/spoiler-2 ¹	spare/spoiler-2 ¹	spare/spoiler-2 ¹	flap-2
6	flaps	combined flap-1 & aileron-2	flaps	flap-1
7	spare	spare	aileron-2	aileron-2
8	spare/spoilers/spoiler-1 ¹	spare/spoilers/spoiler-1 ¹	spare/spoilers/spoiler-1 ¹	spare/spoilers/spoiler-1 ¹
9	spare	spare	spare	spare
10	spare	spare	spare	spare

¹ 2-servo spoiler mode (**SPOILER**). (See p. 83).

² V-tail mixing mode. (See p. 58).

(Wing Type)

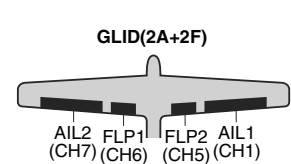
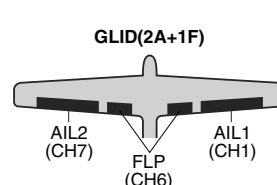
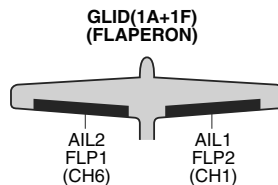
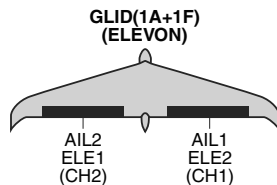

(Tail Type)

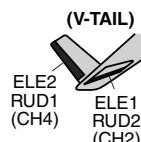
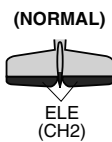

Receiver Output and Channel	Helicopter (HELI)
1	aileron (cyclic roll)
2	elevator (cyclic pitch)
3	throttle
4	rudder
5	spare/gyro
6	pitch (collective pitch)
7	spare/governor
8	spare/mixture control
9	spare
10	spare

(Swash Type)

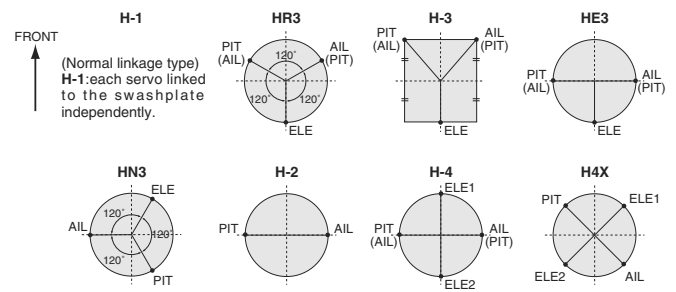

Adjusting the length of the non-slip control sticks

You may change the length of the control sticks to make your transmitter more comfortable to hold and operate.

Stick lever tension adjustment

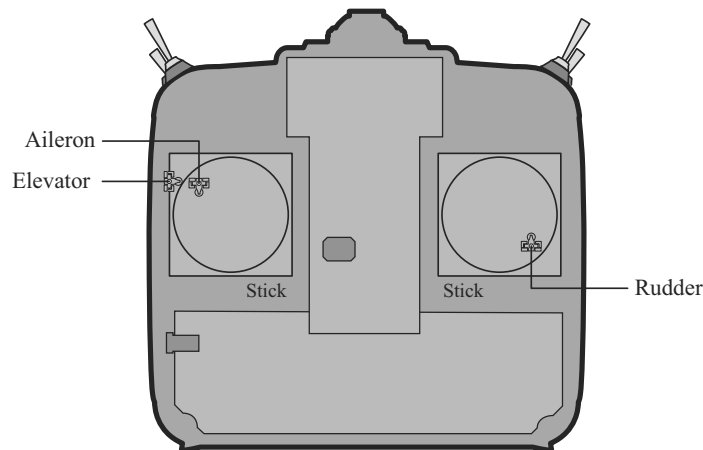

Mode 2 transmitter with rear cover removed.

You may adjust the tension of your sticks to provide the feel that you prefer for flying. To adjust your springs, you'll have to remove the rear case of the transmitter. First, remove the battery cover on the rear of the transmitter. Next, unplug the battery wire, and remove the battery and RF module from the transmitter. While you are removing the RF module, pay attention to the location of the pins that plug into the back of the module. Next, using a screwdriver, remove the four screws that hold the transmitter's rear cover in position, and put them in a safe place. Gently ease off the transmitter's rear cover. Now you'll see the view shown in the figure above.

Using a small screwdriver, rotate the adjusting screw for each stick for the desired spring tension. The tension increases when the adjusting screw is turned clockwise.

When you are satisfied with the spring tensions, reattach the transmitter's rear cover. Check that the upper printed circuit board is on its locating pins, then very carefully reinstall the rear cover being mindful to guide the RF module connector pins through the slot in the case. When the cover is properly in place, reinstall and tighten the four screws. Reinstall the battery, cover and module.

Changing Modes (**TX SETTING**):

[TX SETTING] STK-MODE: 2 THR-REV: NOR LANGUAGE: English LOW BATTERY: 11.1V RF MODE: ON

Hold down **MODE** and **END** keys while turning on the transmitter to call **TX SETTING** menu.

Stick Mode: The screen reads "**STK-MODE**". Change this to the correct mode. Note that this will NOT change the throttle and elevator ratchets, etc. Those are mechanical changes that must be done by a service center.

Throttle Reverse: **THR-REV** is a special function that reverses the entire throttle control, including moving the trim functionality to the Stick's upper half. To use **THR-REV**, **CURSOR DOWN** to **THR-REV** and turn the **DIAL** to **REV**. Turn the transmitter off and back on. This change affects all models in the radio.

Display language: can be selected the display language of the function name, etc. in each function menu. The screen reads "LANGUAGE". Change this to the desired language.

RADIO INSTALLATION

Follow these guidelines to properly mount the servos, receiver and battery.

- Make certain the **alignment tab** on the battery, switch and servo connectors is oriented correctly and “keys” into the corresponding notch in the receiver or connectors before plugging them in. When unplugging connectors, never pull on the wires. Always pull on the plastic connector instead.
- Receiver Antenna: It is normal for the receiver antenna to be longer than the fuselage. **DO NOT cut or fold it back on itself.** cutting or folding changes the electrical length of the antenna and may reduce range. Secure the antenna to the top of the vertical fin, and let the excess wire length trail behind. You may run the antenna inside of a non-metallic housing within the fuselage, but range may suffer if the antenna is located near metal or carbon fiber pushrods or cables. Be sure to perform a range check before flying.
- If your aileron servo (or others) are too far away to plug into the receiver, use an aileron extension cord to extend the length of the servo lead. Additional Radiolink extension cords of varying lengths are available from your hobby dealer. Always use an extension of the proper length. Avoid plugging multiple extensions together to attain your desired length.
- Receiver Vibration and Waterproofing: The receiver contains precision electronic parts. Be sure to avoid vibration, shock, and temperature extremes. **For protection, wrap the receiver in foam rubber or other vibration-absorbing materials.** It is also a good idea to waterproof the receiver by placing it in a plastic bag and securing the open end of the bag with a rubber band before wrapping it with foam rubber. If you accidentally get moisture or fuel inside the receiver, you may experience intermittent operation or a crash. If in doubt, send the receiver for service.

- Always mount the servos with the supplied **rubber grommets**. Do not over tighten the screws. No part of the servo casing should contact the mounting rails, servo tray or any other part of the airplane/helicopter structure. Otherwise, vibration will be transmitted to the servo causing premature wear and/or servo failure.

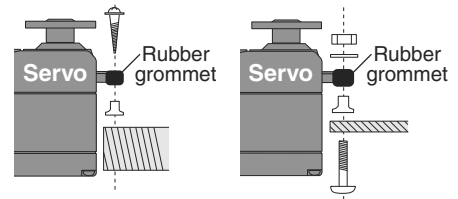

- Note the small numbers (1, 2, 3, 4) molded into each arm on the 4-arm servo arms. The numbers indicate how many degrees each arm is “off” from 90 degrees to correct for minute manufacturing deviations from servo to servo.

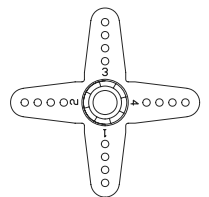

- To center the servos, connect them to the receiver and turn on the transmitter and receiver. Center the trims on the transmitter, then find the arm that will be perpendicular to the pushrod when placed on the servo.

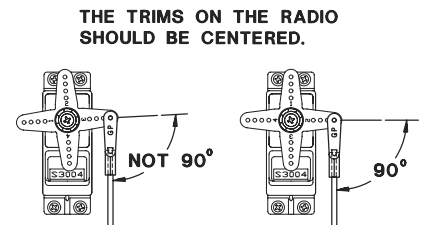

- After the servos are installed, operate each servo over its full travel and check that the pushrods and servo arms do not bind or contact each other. Also make sure the controls do not require excess force to operate. If there is an objectionable buzzing sound coming from a servo, there is probably too much resistance in the control. Find and correct the problem. Even if there is no servo damage, excess battery drain will result.
- Use the **mounting plate** from the receiver on/off switch as a template for the cutout and screw holes. Mount the switch on the side of the fuselage opposite the engine exhaust, and where it won't be inadvertently turned on or off during handling or storage. Be certain the switch moves without restriction and “snaps” from ON to OFF, and that the cutout allows full motion of the switch in both directions.

- When you install the switch harness to the helicopter, please use the switch cover. Generally sandwich the frame by switch and switch cover and securely tighten the screws. Different models might require different installations. In that case, please follow the model instruction manual.

- To prevent the servo lead wires from being broken by vibration during flight, provide a margin so that the wire sticks out slightly and fasten it at suitable points. In addition, periodically check the wire during daily maintenance.

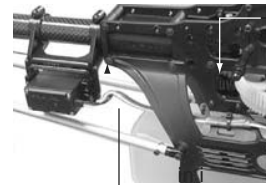

Fasten about 5-10cm from the servo outlet so that the lead wire is neat.

Margin the lead wire

IMPORTANT: Since the 2.4GHz have different characteristics than that of the conventional 27MHz and 72MHz frequencies, please read this section carefully to enjoy safe flight with the 2.4GHz system.

Receiver's Antenna Installation:

- Since the wavelength of the 2.4GHz is much shorter than that of the conventional frequencies 27MHz and 72MHz, it is very susceptible to loss of signal which results in a receiving error. In order to avoid this phenomenon, the R10D adopted a diversity antenna system.
- To obtain the best results of the diversity function, please refer to the following instructions:



1. The antenna must be kept as straight as possible. Otherwise it will reduce the effective range.
2. The antenna must be kept away from conductive materials, such as metal and coaxial part of the antennas does not need to follow these guidelines, but do not bend it in a small radius.
3. Keep the antennas away from the motor, ESC, and other noise sources as much as possible.

BINDING R10D RECEIVER TO THE AT10 TRANSMITTER:

The AT10 transmitter transmit a UUID code, which must be identified by the receiver and stored. This binding procedure needs only to be performed once unless the R10D receiver is to be used with a different transmitter or an additional R10D receiver is to be used with the primary transmitter.

BIND RECEIVER WITH FOLLOWING STEPS:

1. Locate transmitter and receiver within 3 feet of one another.
2. Confirming that the transmitter has full battery power, turn the transmitter to ON position.
3. Connect power from ESC or receiver battery to third channel of receiver.
4. Press binding button (ID set) on the receiver 1 second, the receiver will begin blinking red, indicating the receiver is in binding mode.
5. The LED ceases blinking and glows a steady bright red, confirming a successful bind to transmitter.
6. Turn off receiver, then transmitter. Connect one or more servos to receiver. Power up transmitter, then receiver operate controls to confirm proper binding.

please note that the receiver would not bind with the voltage sensor connected.



- The receiver contains precision electronic parts. It is the most delicate radio component on-board the model and should be protected from vibration, shock and temperature extremes. To protect the receiver, wrap it in R/C foam rubber or other vibration-absorbing material. If appropriate, waterproof the receiver by placing it in a plastic bag and closing the open end with a rubber band before wrapping it in foam. If moisture enters the receiver, intermittent operation or a failure may result. Wrapping the receiver in a plastic bag also protects it from fuel and exhaust residue which, in some models, can work its way into the fuselage.

Product Advisory — R10D Receiver

Whereas many previous receivers offered a signal output of 3.0 Volts, the latest generation of ICs has been designed to operate at lower voltages in order to increase their operational speeds. The R10D receiver utilizes such an IC and, as such, the nominal signal output voltage of the R10D receiver is 2.7 Volts.

While this variance in the output voltage will not affect most equipment in use today, it has been brought to our attention that some manufacturers' products are not capable of operation with the lower signal voltage. That is, they will not operate below 3.0 Volts. Some examples of what we have had reported thus far include sequencers, cut-off valves, older servo designs and some recent non-Radiolink digital servos.

Some battery backup devices might have difficulties with the lower operational voltages as well, although they might not appear to initially. One such device functions perfectly on the ground and during a range check, yet when the operational temperature reaches 50°C (122°F), the device actually requires 2.8 Volts in order to function properly. As such, the servos will cease to operate properly.

Many manufacturers are updating or refining their products to ensure compatibility with the lower operational voltages. If you have any questions about the operation of such peripheral items we strongly suggest that you contact the manufacturer directly.

If you have already purchased items which can not operate below 3.0 Volts, we suggest that you either replace the item with an updated version or utilize a device to increase the voltage accordingly. There are a number of readily available devices that may be used to increase the voltage such as ElectroDynamics' Buffer-Amplifier Interface, Duralite's PowerBox (manufactured within the last six months), EMCotec's DPSI products, Smart-Fly's Power Expander and Powersystem, etc.

Link Procedure:

Each transmitter has an individually assigned, unique ID code. In order to start operation, the receiver must be linked with the ID code of the transmitter with which it is being paired. Once the link is made, the ID code is stored in the receiver and no further linking is necessary unless the receiver is to be used with another transmitter. When you purchase another R6014FS, this procedure is necessary; otherwise the receiver will not work.

1. Place the transmitter and the receiver close to each other within one (1) meter.
2. Turn on the transmitter.
3. Check the LED that is placed on the front side of the transmitter to see if the RF signal is active. When the blue LED is ON solid, the RF signal is being sent.
4. Turn on the receiver.
5. Press down the **Easy Link(ID SET)** switch for more than one second, and release the switch. The receiver starts the linking operation.
6. When the linking is complete, the LED in the receiver will change to solid green. Please confirm that the servos will now operate by your transmitter. Please refer to the table below for the LED status of the receiver's condition.

No signal reception	Red : On
Receiving signals	Green: On
Receiving signals, but ID is unmatched.	Green: Blink
Unrecoverable failure (EEPROM, etc.)	Red and Green turn on alternately.

Transmitter's Antenna:

1. The transmitter antenna is adjustable so please make sure that the antenna is never pointed directly at the model when flying as this creates a weak signal for the receiver.
2. Keep the antenna perpendicular to the transmitter's face to create a better RF condition for the receiver. Of course this depends on how you hold the transmitter, but in most cases, adjusting the transmitter antenna so that it is perpendicular to the face will give the best results. Please adjust the transmitter antenna to the way you hold the transmitter.
3. NEVER grip the antenna when flying as this degrades RF quality.



TRANSMITTER DISPLAYS & BUTTONS

When you first turn on your transmitter, a confirmation double beep sounds, and the screen shown below appears. Before flying, or even starting the engine, be sure that the model type and name appearing on the display matches the model that you are about to fly! If you are in the wrong model memory, servos may be reversed, and travels and trims will be wrong, leading to an immediate crash.

Edit buttons and Start-up Screen (appears when system is first turned on):

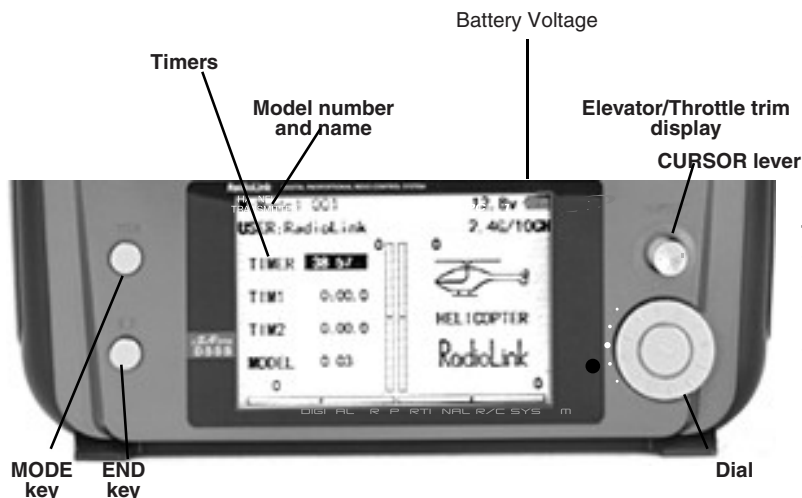

Total timer display <TIMER>

Shows the cumulated ON time. (hours:minutes)

Up/down timer display <ST1.ST2>

(minutes:seconds)

Model timer display <MDL>

Shows the cumulated ON time for each model.(hours:minutes)

Resetting timers:

Select the desired timer with CURSOR lever. The timer display flashes. To reset the timer, press Dial for one second.

MODE BUTTON: (key)

Press and hold **MODE BUTTON** for one second to open programming menus. Press **MODE BUTTON** to switch between **BASIC** and **ADVANCE** menus. Press **MODE BUTTON** to scroll between conditions in certain functions.

END BUTTON: (key)

Press **END BUTTON** to return to previous screen. Closes functions back to menus, closes menus to start-up screen.

CURSOR LEVER:

Control **CURSOR LEVER** to scroll up/scroll down/scroll left/scroll right and select the option to edit within a function.

Press **CURSOR LEVER** to page up/page down within **BASIC** or **ADVANCE** menu or a function.

Turn **DIAL**:

Turn **DIAL** clockwise or counterclockwise to scroll through choices within an option of a function (for example, to select which switch controls dual/triple rates).

Press **DIAL**:

Press **DIAL** to select the actual function you wish to edit from the menu.

Press **DIAL** and hold one second to confirm major decisions, such as the decision to: select a different model from memory, copy one model memory over another, trim reset, store channel position in FailSafe, change model type, reset entire model. System will ask if you are sure.

Press **DIAL** again to accept change.

AIRCRAFT (ACRO) MENU FUNCTIONS

Please note that all **BASIC** menu functions are the same for airplanes (**ACRO**), sailplanes (**GLID**), and helicopters (**HELI**). The glider **BASIC** menu includes **MOTOR CUT** that is discussed in the Glider section and does not include **IDLE-DOWN** or **THR-CUT**; the helicopter **BASIC** menu includes additional features (swashplate adjustment and throttle/pitch curves and revo for Normal flight mode) that are discussed in the Helicopter section.

AIRPLANE (ACRO) FUNCTIONS	16	ACRO ADVANCE MENU FUNCTIONS	38
Map of Functions.....	17	Wing types	38
Quick Guide to Setting up a 4-channel Airplane	18	FLAPERON	39
ACRO BASIC MENU FUNCTIONS	20	FLAP TRIM	40
MODEL Submenu: MODEL SELECT, COPY, NAME	20	Aileron Differential (AILE-DIFF).....	41
PARAMETER Submenu: RESET, TYPE, MODUL, ATL, AILE-2,		Using a 5-channel receiver: AILE-2	42
CONTRAST, BACK-LIGHT, HOME-DISP, USER NAME, LOGIC		ELEVON (see tail types)	43
SW	23	Tail types	43
Servo REVERSE	26	ELEVON	43
END POINT	27	Twin Elevator Servos (AILEVATOR).....	44
Idle Management: IDLE DOWN and THR-CUT	28	V-TAIL	45
Dual/Triple Rates and Exponential (D/R, EXP).....	30	SNAP ROLL	45
TIMER Submenu.....	33	Mixes: definitions and types	47
Auxiliary Channel assignments and CH9 reverse (AUX-		ELEV-FLAP	48
CH).....	34	AIRBRAKE/BUTTERFLY (crow)	48
TRAINER	34	THROTTLE-NEEDLE	50
TRIM and SUB-TRIM	35	THROTTLE DELAY	51
SERVO Display	37	THROTTLE CURVE	53
Fail Safe and Battery FailSafe (F/S).....	37	Linear, Prog. mixes 1-4	53
		Curve, Prog. mixes 5-8	55
		GYA gyro mixing (GYRO SENSE)	

MAP OF ACRO BASIC FUNCTIONS

(Startup screen)

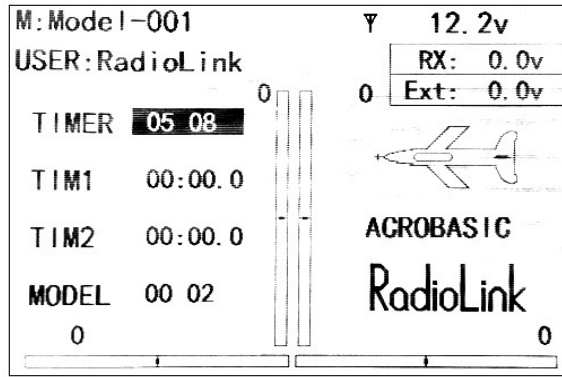

To enter the Basic Menu, press the Mode key for one second.



(for one second)



To return to the Startup screen, press the End key.

ACRO Basic Menu

[BASIC MENU]

< ACROBASIC Model-001 >

MODEL	THR CUT	TIMER
D/R, EXP	IDLE DOWN	TRAINER
END POINT		LOGIC SW
SUB-TRIM	PARAMETER	SERVO
REVERSE	F/S	SERVO VIEW
TRIM	AUX-CH	

[ADVANCE MENU]

< ACROBASIC Model-001 >

PROG. MIX	AILVATOR	THR DELAY
FLAPERON	SNAP ROLL	THR NEEDLE
FLAP TRIM	V-TAIL	
AILE-DIFF	ELEVON	
AIR BRAKE	GYRO SENSE	
ELEV FLAP	THR-CURVE	



Press Mode key to toggle back and forth between BASIC and ADVANCE menus.



Press Cursor lever to page up and down through the 1 page of screens in each menu.

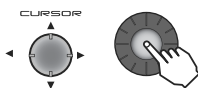

Use Cursor lever to highlight function in Menu screen. Then press the Dial to choose that function.

Mode Select

Switch Up

Stick Up

End Selection

Switch at Center

Stick Right

Cursor Lever (Down/Up/Left/Right)

Switch Down

Stick Down

Press Cursor Lever

Turn Knob Right

Stick Left

Dial Left

Turn Knob Left

Dial Right

Dial Right or Left

Press Dial

A QUICK GUIDE: GETTING STARTED WITH A **BASIC** 4-CHANNEL AIRCRAFT

This guide is intended to help you get acquainted with the radio, to give you a jump start on using your new radio, and to give you some ideas and direction in how to do even more than you may have already considered. It follows our basic format of all programming pages: a big picture overview of what we accomplish; a “by name” description of what we’re doing to help acquaint you with the radio; then a step-by-step instruction to leave out the mystery when setting up your model.

For additional details on each function, see that function's section in this manual. The page numbers are indicated in the goals column as a convenience to you.

See p.17 for a legend of symbols used.

GOALS of EXAMPLE	STEPS	INPUTS for EXAMPLE
Prepare your aircraft.	Install all servos, switches, receivers per your model's instructions. Turn on transmitter then receiver; adjust all linkages so surfaces are nearly centered. Mechanically adjust all linkages as close as possible to proper control throws. Check servo direction. Make notes now of what you will need to change during programming.	
Name the model. P. 22. <i>[Note that you do not need to do anything to "save" or store this data. Only critical changes such as a MODEL RESET require additional keystrokes to accept the change.]</i>	Open the BASIC menu, then open the MODEL submenu.	Turn on the transmitter. Ⓜ for 1 second. (If ADVANCE , Ⓜ again.) ⏪ as needed to highlight MODEL . ⏩ to choose MODEL .
	Go to MODEL NAME .	⏪ to NAME . (First character of model's name is highlighted.)
	Input aircraft's name. Close the MODEL submenu.	⏪ to change first character. When proper character is displayed, ⏪ to move to next character. Repeat as needed. Ⓜ to return to BASIC menu.
Reverse servos as needed for proper control operation. P. 26.	In the BASIC menu, open (servo) REVERSE .	⏪ to REVERSE . ⏩ to choose REVERSE .
	Choose desired servo and reverse its direction of travel. (Ex: reversing rudder servo.)	⏪ to CH4: RUDD . ⏪ so REV is highlighted. Repeat as needed. Ⓜ
Adjust Travels as needed to match model's recommended throws (usually listed as high rates). P. 27.	From BASIC menu, choose END POINT .	⏪ to END POINT . ⏩ to choose END POINT .
	Adjust the servo's end points. (Ex: throttle servo) Close the function.	⏪ to THROTTLE . ⏪ THROTTLE STICK . ⏪ until carb barrel closes as desired. ⏪ THROTTLE STICK . ⏪ until throttle arm just opens carb fully at full THROTTLE STICK . Repeat for each channel as needed. Ⓜ

With digital trims you don't shut the engine off with **THROTTLE TRIM**. Let's set up **IDLE-DOWN** and "throttle cut" (**THR-CUT**) now.

GOALS of EXAMPLE	STEPS	INPUTS for EXAMPLE
<p>Set up IDLE-DOWN. P. 28</p> <p>IDLE-DOWN slows the engine's idle for landings, sitting on the runway, and maneuvers such as spins. The normal (higher idle) setting (when IDLE-DOWN is off) is for engine starting, taxi, and most flight maneuvers, to minimize chance of a flame-out.</p>	<p>From the BASIC menu, choose IDLE-DOWN.</p>	<p> to IDLE-DOWN. to choose IDLE-DOWN.</p>
	<p>Activate and adjust IDLE-DOWN.</p>	<p> to MIX. to OFF. C to center position. Screen now reads ON. to RATE. to increase rate until engine idles reliably but low enough to sit still.</p>
	<p>Optional: change switch command from C center-and-down to any other switch.</p>	<p>(Not needed in this example.)</p>
	<p>Close the Function.</p>	<p></p>
<p>THR-CUT shuts the engine off completely with the flip of a switch. P. 29.</p> <p><i>(NOTE: DO NOT assign IDLE-DOWN and THR-CUT to both positions of a 2position switch. See IDLE-DOWN for details.)</i></p>	<p>From the BASIC menu, choose THR-CUT.</p>	<p> to THR-CUT. to choose THR-CUT.</p>
	<p>Activate, assign SWITCH and adjust. Close the function.</p>	<p> to MIX. to OFF. to SW. to C. to POSI. to DOWN. to RATE. C to down position. THROTTLE STICK. until throttle barrel closes completely.</p>
<p>Set up dual/triple rates and exponential (D/R,EXP). P. 30.</p> <p><i>(Note that in the middle of the left side of the screen is the name of the channel AND the switch position you are adjusting. Two or even THREE rates may be set per channel by simply choosing the desired switch and programming percentages with the switch in each of its 2 or 3 positions.)</i></p>	<p>From the BASIC menu, choose D/R,EXP.</p>	<p> to D/R,EXP. to choose D/R,EXP.</p>
	<p>Choose the desired control, and set the first (Ex: high) rate throws and exponential.</p>	<p> A to up position. to CH. to choose CH>2 (elevator). [note the screen reads ELEV (UP)] to D/R. ELEVATOR STICK. to set desired "UP" percentage. ELEVATOR STICK. as needed to adjust "DOWN" percentage (normally set the same as down.) to EXP. ELEVATOR STICK. to set. ELEVATOR STICK. to set.</p>

GOALS of EXAMPLE	STEPS	INPUTS for EXAMPLE
	Set the second (low) rate throws and exponential.	A to down position. to D/R . Repeat steps above to set low rate.
	<i>Optional: change dual rate switch assignment. Ex: elevator to switch G (AT10) or E (AT10) with 3 positions.</i>	to SW . to G or E . G or E to center position. Repeat steps above to set 3rd rate.
<i>Where next?</i>	(Other functions you may wish to set up for your model.) TRAINER p. 34. Multiple wing and/or tail servos: see wing types and tail types, p. 38,45. Elevator-to-flap, Rudder-to-aileron, flap-to-elevator, and other programmable mixes p. 53. Retractable Gear, Flaps on a Switch, Smoke systems, kill switches, and other auxiliary channel setups. p. 34.	

A LOOK AT THE RADIO'S FUNCTIONS STEP BY STEP

MODEL submenu: includes three functions that manage model memory: **MODEL SELECT**, **MODEL COPY** and **MODEL NAME**. Since these functions are all related, and are all basic features used with most models, they are together in the **MODEL** submenu of the **BASIC** menu.

[MODEL]
SELECT: 01 (Model-001 ACROBASIC)
COPY: 01→01 (Model-001 ACROBASIC)
NAME: Model-001

MODEL SELECT: This function selects which of the 15 model memories in the transmitter to set up or fly.

For clarity the model's name and an image of its type are indicated after its number. (Each model memory may be a different model type from the other memories.)

NOTE: When you choose a new model in the **MODEL SELECT** function, if the new model is set to the other modulation, you must cycle the transmitter power to change modulations. If you do not cycle the power, the modulation type will flash on the home screen to remind you. You are still transmitting on the other modulation until you affect this change.

GOAL:	STEPS:	INPUTS:
Select Model #3. <i>NOTE: This is one of several functions for which the radio requires confirmation to make a change.</i>	Open BASIC menu, then open MODEL submenu.	for 1 second. (If ADVANCE again.) if required to MODEL
	Choose Model #3.	to 3 .
	Confirm your change.	for 1 second. Are you sure? displays.
	Close.	
Confirm proper modulation of new model memory.	If 2.4G are flashing in the upper right hand corner, then the new model is set for the other receiver type. Turn the transmitter off/on to change the modulation.	
<i>Where next?</i>	NAME the model: see p. 22. Change MODEL TYPE (aircraft, heli, glider): see p. 23. Utilize servo REVERSE : see p. 26. Adjust END POINTS : see p. 27. Set up IDLE-DOWN and THR-CUT for throttle management: see p. 28, 29.	

MODEL COPY: copies the current model data into another model memory.
The name of the model memory you are copying into is displayed for clarity.

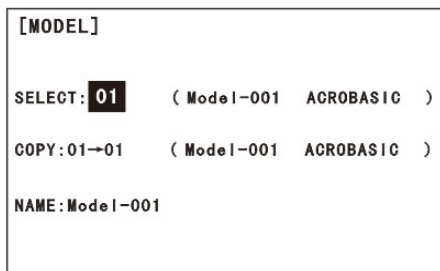

Notes:

- Any data in the model copied to will be written over and lost, including name, type and modulation. It cannot be recovered.
- With the trainer **FUNC** mode it is not necessary to have the student radio contain the setup of the aircraft. See **TRAINER**, p. 34

Data cannot be converted from 8U or 9Z memory types.

Examples:

- Start a new model that is similar to one you have already programmed.
- Copy the current model data into another model memory as a backup or before experimenting with new settings.
- Edit a copy of your model's data to fly the model in different conditions (ie. Helicopter using heavier night blades; glider in extreme wind; airplane model at extreme altitudes).

GOAL of EXAMPLE:	STEPS:	INPUTS:
Copy model 3 into model 5. <i>NOTE: This is one of several functions for which the radio requires confirmation to make a change.</i>	Open the BASIC menu, then open MODEL submenu.	for 1 second. (If ADVANCE , again.) to MODEL .
	Confirm you are currently using the proper model memory. (Ex: 3)	If SELECT does not indicate 3 , use MODEL SELECT , p. 20.
	Go to MODEL COPY and choose the model to copy into. (Ex: 5)	to COPY . to 5 .
	Confirm your change.	for 1 second. Are you sure? displays. *
	Close.	
Where next?	SELECT the copy you just made: see p. 20. Rename it (it is currently named exactly the same as the model copied): see p. 22.	

*Radio emits a repeating "beep" and shows progress on screen as the model memory is being copied. Note that if the power switch is turned off prior to completion, the data will not be copied.

MODEL NAME: assigns a name to the current model memory. By giving each model a name that is immediately recognizable, you can quickly select the correct model, and minimize the chance of flying the wrong model memory which could lead to a crash.

```
[MODEL]
SELECT: 01 ( Model-001 ACROBASIC )
COPY: 01→01 ( Model-001 ACROBASIC )
NAME: Model-001
```

Adjustability and values:

- Up to 9 characters long.
- Each character may be a letter, number, blank, or a symbol.
- The default names assigned by the factory are in MODEL-xxx format (**MODEL-001** for first model memory, etc.)

NOTE: When you **COPY** one model memory over another, **everything** is copied, including the model's name. Similarly, if you change **MODEL TYPE** or do a **MODEL RESET**, the entire memory is reset, including **MODEL NAME**. So the first thing you will want to do after you **COPY** a model, change its type, or start from scratch, is rename the new copy to avoid confusion.

GOAL of EXAMPLE:	STEPS:	INPUTS:
Name model 3 “Cap-232_” (where the underline represents a blank space.)	Open MODEL submenu.	for 1 second. (If ADVANCE , again.) to MODEL .
	Confirm you are currently using the proper model memory. (Ex: 3)	If SELECT does not indicate 3 , perform MODEL SELECT , p. 20.
	Go to NAME and change the first character. (Ex: M to C)	to M to C .
	Choose the next character to change.	
	Repeat the prior steps to complete naming the model.	to a (note: lower case is available) Repeat.
	Close.	
<i>Where next?</i>	Change the MODEL TYPE to glider or helicopter: see p. 23. Utilize servo REVERSE : see p. 26. Adjust servo travel with END POINT : see p. 27. Set up dual/triple rates and exponential (D/R, EXP): see p. 30.	

PARAMETER submenu: sets those parameters you would likely set once, and then not disturb again.

Once you have selected the correct model you wish to work with, the next step is setting up the proper parameters for this specific model:

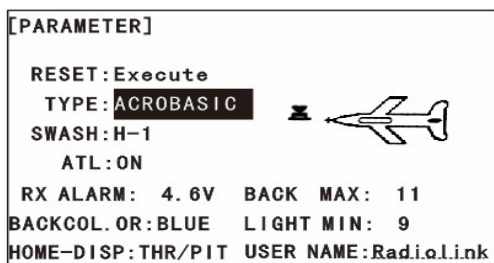

First it is important to clear out any old settings in the memory from prior use, using the **MODEL RESET**.

MODEL RESET: completely resets all data in the individual model you have currently selected. Don't worry - there is no way you can accidentally delete all models in your radio with this function. Only a service center can completely reset your radio's entire memory at once. To delete each model in your radio's memory (for example when selling), you must **SELECT** each model, reset that memory, then go **SELECT** the next memory, etc.

Note that when you **COPY** one model memory into another or change the model's type, you need not delete all existing data first by using this function. **COPY** completely overwrites anything in the existing model memory, including **MODEL NAME**. The **MODEL TYPE** function overwrites all data except name and **MODUL**.

GOAL of EXAMPLE:	STEPS:	INPUTS:
Reset model memory 1.	Confirm you are currently using the proper model memory. (Ex: 1)	On home screen, check model name and number on top left. If it is not correct, use MODEL SELECT , p. 20.
<i>NOTE: This is one of several functions for which the radio requires confirmation to make a change.</i>	Open PARAMETER submenu.	(MODE) for 1 second. (If ADVANCE , (MODE) again. ⊙ to PARAMETER . ⊙
	Reset the Memory.	⊙ for one second.
	Confirm the change.	Are you sure? displays. ⊙ *
	Close.	(END) (END)
	<i>Where next?</i>	Now that the memory is reset, name has returned to the default (Ex: MODEL-001). NAME the model: p. 22. COPY a different model into this memory: p. 21. SELECT a different model to edit or delete: p. 20. Change the MODEL TYPE to glider or helicopter: see p. 23. Utilize servo REVERSE : see p. 26. Adjust servo travel with END POINT : see p. 27. Set up dual/triple rates and exponential (D/R,EXP): see p. 30.

*Radio emits a repeating “beep” and shows progress on screen as the model memory is being reset. Note that if the power switch is turned off prior to completion, the data will not be reset.

MODEL TYPE: sets the type of programming used for this model.

The AT10 has 15 model memories, which can each support:

- one powered aircraft (**ACRO**) memory type (with multiple wing and tail configurations. See twin aileron servos, twin elevator servos, **ELEVON**, and **V-TAIL** for further information.);
- three glider wing types (again with multiple tail configurations). See Glider **MODEL TYPE** for details, p. 61;
- eight helicopter swashplate types, including CCPM. See Helicopter **MODEL TYPE** for details, p. 73.

Before doing anything else to set up your aircraft, first you must decide which **MODEL TYPE** best fits this particular aircraft. (Each model memory may be set to a different model type.) If your transmitter is a AT10, the default is **ACRO**. If it is a AT10, the default is **HELICH1**.

ACRO is the best choice for most powered airplanes, but in some circumstances, **GLID(2A+1F)** may be a better choice. **ACRO** is usually a better choice because of functions it offers that the **GLID** types do not:

- ACRO** adds:
 - SNAP-ROLL**
 - AILEVATOR** (twin elevator servo support)
 - For fuel-powered airplanes: **IDLE-DOWN**, **THR-CUT**, **THROTTLE-NEEDLE** mixing and **THROTTLE DELAY** programming.
- But **ACRO** lacks:
 - 5 separate conditions for optional setups (**START/SPEED/DISTANCE/LANDING**)

If you are using a glider or heli **MODEL TYPE**, please go to that chapter now to select the proper model type and support your model setup. Note that changing **MODEL TYPE** resets all data for the model memory, including its name.

GOAL of EXAMPLE:	STEPS:	INPUTS:
Select the proper MODEL TYPE for your model. Ex: ACRO .	Open the BASIC menu, then open the PARAMETER submenu.	Turn on the transmitter. for 1 second. (If ADVANCE , again.) then to highlight PARAMETER . to choose PARAMETER .
<i>[NOTE: This is one of several functions that requires confirmation to make a change. Only critical changes require additional keystrokes to accept the change.]</i>	Go to MODEL TYPE .	to TYPE .
	Select proper MODEL TYPE . Ex: ACRO . Confirm the change. Close PARAMETER .	to ACROBATIC . for 1 second. Are you sure? displays. to confirm. to return to BASIC menu.

Second aileron (AILE-2) (ACRO/GLID 1A+1F/GLID 2A+1F only): changes the default choice for dual aileron servos from channels 6 (**FLAPERON**) to channels 5 and 6, or 7(**AIL-DIF**) to channels 5 and 7. This allows you to utilize these 2 great functions while utilizing a 5-channel receiver.

NOTE: Changing **AILE-2** only tells the system which servos to utilize if **FLAPERON** or **AIL-DIF** is activated. You still must activate that function and complete its setup. For details on twin aileron servos, including using **AILE-2**, see p. 42.

Adjustable travel limit (ATL): makes the channel 3 **TRIM LEVER (THROTTLE TRIM)** effective only at low throttle, disabling the trim at high throttle. This prevents pushrod jamming due to idling trim changes. This function defaults to **ON**. If you are not using channel 3 for throttle, you may want trim operation the same as on all other channels. To do so, set **ATL** to **OFF**. If you need the **ATL** to be effective at the top of the stick instead of the bottom, reverse the **THR-REV** setting. Note that this affects all models in the radio, not just the model you are currently editing. See servo **REVERSE**, p. 26.

GOAL of EXAMPLE:	STEPS:	INPUTS:
Change ATL from ON to OFF for battling robot, tank, airbrake and other channel 3 uses.	Open BASIC menu, then open PARAMETER submenu.	(MODE) for 1 second. (If ADVANCE , (MODE) again.) to PARAMETER .
	Go to ATL and Change. (Ex: to OFF)	to ATL . to OFF .
	Close.	(END) (END)
Where next?	Set up ELEVON for tank-style control, throttle/steering on one STICK: see p. 43. Set up IDLE-DOWN and THR-CUT to adjust channel 3 servo at low-stick: see p. 28. Reassign auxiliary channels 5-8 (ex: from dial to switch/slider): see p. 34. Utilize servo REVERSE : see p. 26. Adjust servo travel with END POINT : see p. 27. Set up dual/triple rates and exponential(D/R.EXP): see p. 30.	

LCD screen backcolor adjustment

BACKCOLOR: set a LCD screen backcolor from Black to Blue, or Green.

Home screen display mode selection (HOME-DISP) (HELI only): selects the display item in the home screen for **HELI**.

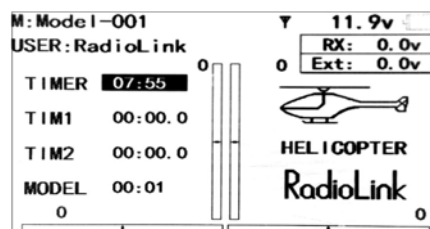
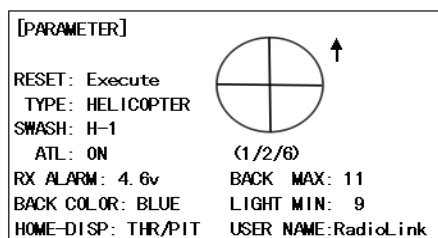

ILLUST mode

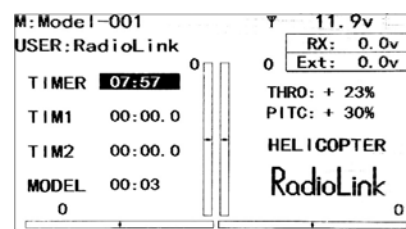

THR/PIT mode

ILLUST: displays the illustration of helicopter in the home screen. (default)

THR/PIT: displays the current throttle and pitch position in the home screen.

GOAL of EXAMPLE:	STEPS:	INPUTS:
Change the display mode from ILLUST to THR/PIT .	Open BASIC menu, then open PARAMETER submenu.	(MODE) for 1 second. (If ADVANCE , (MODE) again.) to PARAMETER .
	Go to HOME-DISP and change setting. (Ex: THR/PIT)	to HOME-DISP . to THR/PIT .
	Close.	(END) (END)

USER NAME: assigns your transmitter's name which is displayed in the home screen.

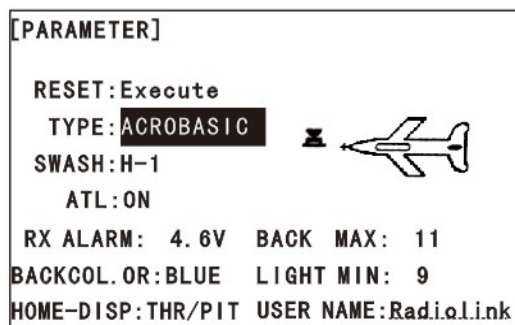

Adjustability and values:

- Each character may be a letter, number, blank, or a symbol.
- The default name assigned by the factory is "Radiolink" logo.

GOAL of EXAMPLE:	STEPS:	INPUTS:
Name USER NAME "Radiolink".	Open BASIC menu, then open PARAMETER submenu.	(MODE) for 1 second. (If ADVANCE , (MODE) again.) ⬅ to PARAMETER . ⌚
	Go to USER NAME and select the first character. (Ex: _ to F)	⬅ to USER NAME ⌚ to F .
	Choose the next character to change.	⬅
	Repeat the prior steps to complete naming the model.	⌚ to U (note: lower case is available) Repeat.
	Close.	(END) (END)

Logic switch selection (LOGIC SW): The various functions in the AT10 can be selected by switch. The Logic switch can be assigned to the following functions: **THR-CUT**, **IDLE DOWN**, **AUX-CH**, **TIMER**, **PROG. MIX**, **AIRBRAKE**, **ELEV-FLAP**, and **AILE-FLAP** functions. The logic switch can activate functions by two switches combination. The 2 types of logic, either AND or OR, can be selected.

```
[LOGIC SW]
LSW1(OFF) 2(OFF) 3(OFF)
SW▶A ▶A ▶A
POSI▶NULL ▶NULL ▶NULL
MODE▶X/and ▶X/and ▶X/and
SW▶A ▶A ▶A
POSI▶NULL ▶NULL ▶NULL
```

Adjustability:

- Three logic switches can be used. (**LSW1**, **LSW2**, and **LSW3**)
- SW(1): Any **SWICH A-H** or **THR-STKS**, SW(2): Any **SWICH A-H**
- Switch position (**POSI**)
- Logic mode: AND or OR (**MODE**)

Logic combination table:

SWITCH		LOGIC	
SW(1)	SW(2)	AND	OR
off	off	off	off
off	on	off	on
on	off	off	on
on	on	on	on

GOAL of EXAMPLE:	STEPS:	INPUTS:
Ex: Switch A and B are calculated by AND logic. (A = down, B = down)	Open BASIC menu, then open LOGIC SW menu.	(MODE) for 1 second. (If ADVANCE , (MODE) again.) ⬅ to LOGIC SW . ⌚
	Go to POSI and change setting. (Ex: DOWN)	⬅ to POSI . ⌚ to DOWN .
	Next, SW= B , POSI=DOWN	Repeat.
	Close.	(END) (END)

Servo reversing (REVERSE): changes the direction an individual servo responds to a **CONTROL STICK** motion.

[Since channel 9 and 10 are switch only, its servo **REVERSE** is in the **AUX-CH** control screen with its switch assignment.

For CCPM helicopters, be sure to read the section on **SWASH AFR** (p. 75) before reversing any servos.

```
[REVERSE]    →1:AILE  NOR
              2:ELEV  NOR
              3:THRO  NOR
CH1:AILERON  4:RUDD  NOR
  REV  NOR   5:GEAR  NOR
              6:FLAP  NOR
              7:AUX1  NOR
              8:AUX2  NOR
```

Except with CCPM helicopters, always complete your servo reversing prior to any other programming. If you use pre-built **ACRO/GLID** functions that control multiple servos, such as **FLAPERON** or **V-TAIL**, it may be confusing to tell whether the servo needs to be reversed or a setting in the function needs to be reversed. See the instructions for each specialized function for further details.

❗ **Always check servo direction prior to every flight as an additional precaution to confirm proper model memory, hook ups, and radio function.**

NOTE: THR-REV is a special function that reverses the entire throttle control, including moving the trim functionality to the Stick's upper half. To use **THR-REV**, turn off the transmitter, hold down the **MODE** and **END** keys, turn on. **CURSOR DOWN** to **THR-REV** and turn the **DIAL** to **REV**. Turn the transmitter off and back on. This change affects all models in the radio.

GOAL of EXAMPLE:	STEPS:	INPUTS:
Reverse the direction of the elevator servo.	Open REVERSE function.	MODE for 1 second. (If ADVANCE , MODE again.) ⤴ to REVERSE . ⚙️
	Choose proper channel and set direction. (Ex: ELE REV)	⤴ to ELE . ⚙️ to REV . ⚙️ for 1 second.
	Close.	END END
Where next?	Adjust servo travel with END POINT : see p. 27. Set up dual/triple rates and exponential(D/R,EXP): see p. 30. Set up flight timers: see p. 33. Set up trainer functions: see p. 34.	

End Point of servo travel adjustment (END POINT, also called EPA): the most flexible version of travel adjustment available. It independently adjusts each end of each individual servo's travel, rather than one setting for the servo that affects both directions. Again, for CCPM helicopters, be sure to see **SWASH AFR** (see p. 73) prior to adjusting end points.

```
[END POINT] →1:AILE 100/100
              2:ELEV 100/100
              3:THRO 100/100
CH1:AILERON  4:RUDD 100/100
  ← →       5:GEAR 100/100
100% 100%   6:FLAP 100/100
              7:AUX1 100/100
              8:AUX2 100/100
```

Adjustability:

- Can set each direction independently.
- Ranges from 0% (no servo movement at all) to 140%. At a 100% setting, the throw of the servo is approximately 40° for channels 1-4 and approximately 55° for channels 5-8.
- Reducing the percentage settings reduces the total servo throw in that direction.

Examples:

- Adjust the throttle high end to avoid binding at the carburetor, and low end to allow for proper carburetor closure.
- Adjust flap so up travel is only sufficient for straight and level flight trimming, with full down travel.
- **END POINT** may be adjusted to 0 to keep a servo from moving one direction, such as flaps not intended to also operate as spoilers.
- Retract servos are not proportional. Changing **END POINT** will not adjust the servo.

END POINT adjusts only the individual servo. It will have no effect on any other servo that is operated in conjunction with this servo via mix or preset programming such as **FLAPERON**, **AILEVATOR**, etc. This is so that each individual servo can be carefully fine-tuned to avoid binding and other conflicts. To adjust the total travel of a function such as **FLAPERON**, make the adjustments in that function's controls. For CCPM helicopters, adjust the total travel of the function, such as collective pitch, in **SWASH AFR**.

Adjust the linkage or the **END POINT**? It is nearly always best to adjust your linkages to get as close as possible prior to utilizing **END POINT**. The higher the **END POINT** setting, the better position accuracy and the more servo power available at nearly any position (except if using digital servos). Higher **END POINT** values also mean longer travel time to reach the desired position, as you are utilizing more of the servo's total travel. (For example, using 50% **END POINT** would give you only half the steps of servo travel, meaning every click of trim has twice the effect and the servo gets there in half the time).

- end point (and moving the linkage) = torque, accuracy, but transit time to get there.
- end point (instead of adjusting linkages) = travel time, but torque, accuracy.

GOAL of EXAMPLE:	STEPS:	INPUTS:
Decrease the flap servo throw in the upward direction to 5% to allow trimming of level flight only and down travel to 85% to prevent binding.	Open END POINT function.	for 1 second. (If ADVANCE , again.) to END POINT .
	Choose proper channel and move stick or knob in direction you want to adjust and set servo throw. (Ex: flap up 5%)	to FLAP . flap control [default is <i>VR(A)</i>]. to 5%.* <i>VR(A)</i> . to 85% .
	Close.	
<i>Where next?</i>	Go to SERVO display to confirm desired end result: see p. 37. Move auxiliary channels 5-10 to different dial(s)/switch(es)/slider(s): see p. 46. Set up IDLE-DOWN and THR-CUT to slow/cut the engine: see p. 28. Set up dual/triple rates and exponential(D/R,EXP): see p. 30. Set up flight timers: see p.33. Set up trainer functions: see p. 34. Set up twin aileron servos: see p. 39. Set up twin elevator servos: see p. 44.	

*You can reset to the initial values by pressing the **DIAL** for one second.

Engine idle management: IDLE-DOWN and **THR-CUT**: functions which work with the digital **THROTTLE TRIM** to provide a simple, consistent means of engine operation. No more fussing with getting trim in just the right spot for landings or take offs! For additional engine adjustments, see **THROTTLE-NEEDLE** (p. 50) and **THROTTLE DELAY** (p. 51).

IDLE-DOWN (ACRO only): lowers the engine idle for: sitting on the runway prior to take off, stalls and spins, and landings. The normal idle setting is a little higher for easier starts and safe flights with less risk of dead sticks.



Important note: The **IDLE-DOWN** function is not normally used when starting the engine, and its accidental operation may keep your engine from starting. The AT10 warns that **IDLE-DOWN** is on when the transmitter is turned on. Be sure to turn off the function, or override the warning by pressing **CURSOR** lever if you intended the function to be on.

This may be assigned to any switch/position. Some modelers accidentally assign **IDLE-DOWN** to one side of a switch and **THR-CUT** to the other. There is no “normal” setting to start the engine. By default **IDLE-DOWN** is set to **SWITCH C** center and down. This works well with **THR-CUT** also on **SWITCH C** down. The SWITCH up is normal flight/starting, center for slower maneuvers/landing, and down to cut the engine. If you assign **IDLE-DOWN** or **THR-CUT** to the spring-loaded **TRAINER SWITCH F**, then use the trainer function, you may risk loss of throttle control or deadstick for your student.

GOAL of EXAMPLE:	STEPS:	INPUTS:
Decrease the throttle setting at idle with the flip of a switch for spins and landings.	Open BASIC menu, then open IDLE-DOWN function.	(MODE) for 1 second. (If ADVANCE , (MODE) again.) ⊕ to IDLE-DOWN . ⚙
	Activate the function.	⊕ to MIX . ⚙ to OFF .
	With THROTTLE STICK at idle, adjust the rate until engine idles as desired.*	⊕ THROTTLE STICK . ⊕ to RATE . ⚙ until engine idles as desired.
	Optional: change switch assignment. Choose desired switch and position.**	⊕ to SW . ⚙ to desired SWITCH . ⊕ to POSI . ⚙ to desired position.
	Close.	(END) (END)
Where next?	THR-CUT : see p. 29.	

*Normally a value of 10- 20%. Secure the fuselage, engine running. Set the **THROTTLE STICK** to idle. Adjust the **IDLE-DOWN** rate while flipping the switch ON and OFF until the desired idle is achieved. Be sure to throttle up periodically to allow the engine to “clean out” and idle reliably.

Also **LOGIC SW(Lsw1 to 3) may be assigned. Set up **LOGIC SW**: See p. 26.

Throttle cut (THR-CUT) (ACRO/HELI): provides an easy way to stop the engine by flipping a switch (with **THROTTLE STICK** at idle). The movement is largest at idle and disappears at high throttle to avoid accidental dead sticks. In **HELI**, there is an additional setting, **THR-HOLD**. See p. 79.

[THROTTLE CUT]

```
MIX▶INH
RATE▶02
SW▶SwA
POSI▶NULL
```

The switch's location and direction must be chosen. It defaults to **NULL** to avoid accidentally assigning it to a switch, which might result in an unintentional dead stick in flight. Please see for **IDLE-DOWN** and **THR-CUT** on p. 28.

GOAL of EXAMPLE:	STEPS:	INPUTS:
Decrease the throttle setting (at idle) to stop the engine with the flip of a switch. (Note that you MUST assign a switch. The default is NULL . We recommend SWITCH C in the down position, with IDLE-DOWN programmed to SWITCH C in the center and down positions.)	Open BASIC menu, then open THR-CUT function.	(MODE) for 1 second. (If ADVANCE , (MODE) again.) ⊕ to THR-CUT . ⚙
	Activate the function. Choose desired switch, and the position which activates the function.**	⊕ to MIX . ⚙ ⊕ to SW . ⚙ to C . ⊕ to POSI . ⚙ to DOWN .
	With THROTTLE STICK at idle, adjust the rate until the engine consistently shuts off but throttle linkage is not binding.*	⬇ C to down position. ⊕ THROTTLE STICK . ⊕ to RATE . ⚙ until shuts off.
	Close.	(END) (END)
Where next?	Set up dual/triple rates and exponential (D/R,EXP): see p. 30. Set up TRAINER functions: see p. 34. Set up twin aileron servos: see p. 39. Set up twin elevator servos: see p. 44.	

*Normally, a setting of 10-20% is sufficient. Viewing the carburetor barrel until it fully closes is adequate to get an approximate setting; then test with engine running to confirm.

Also **LOGIC SW(Lsw1 to 3) may be assigned. Set up **LOGIC SW**: See p. 26.

Dual/triple rates and exponential (**D/R,EXP**): assigns adjusted rates and exponential.

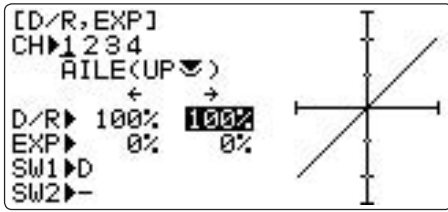

Dual/Triple Rates: reduce/increase the servo travel by flipping a switch, or (**ACRO/GLID**) they can be engaged by any stick position. Dual rates affect the control listed, such as aileron, not just a single (ex: channel 1) servo. For example, adjusting aileron dual rate will affect both aileron servos when using **FLAPERON** or **AIL-DIF**, and both aileron and elevator servos' travel when using **AILLEVATOR** or **ELEVON** or a CCPM helicopter.

Activation:

- Any **SWITCH, A-H**. If you choose a 3-position switch, then that dual rate instantly becomes a triple rate (see example).
- The glider programming offers you the choice of **Cond**. This option allows you to have a separate rate for each of condition. (**GLID**)
- Stick position (**ACRO/GLID**). (Ex: On rudder you normally use only the center 3/4 of the stick movement except for extreme maneuvers such as snaps/spins/stalls. As long as your RUDDER STICK does not exceed 90% of maximum throw, the rudder responds at your lower rate, allowing small, gentle corrections. When the stick passes 90% (ie. stall turn), the rudder goes to high rate's 90%, which is a MUCH higher amount of travel than your low rate at 89%.)

Ex: (At 100% = 1")

	Low Rate = 50%	High Rate = 100%
At 89%	Low Rate = .45"	
At 90%		High Rate = .9"

[Note] Only if any stick is chosen by the item of "SW1", a switch can also be chosen by the item of "SW2." When operated simultaneously, the switch operation has priority over the stick operation. (**ACRO**)

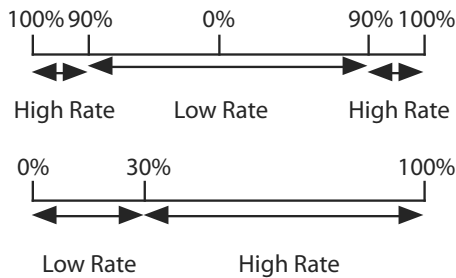

Adjustability:

- Range: 0 - 140% (0 setting would deactivate the control completely.) Initial value=100%
- Adjustable for each direction (**ACRO/GLID**). (ie. Up/down, left/right) (Ex: Most models fly upright without any elevator trim, but require some down elevator when inverted just to maintain level flight. By increasing the down travel by the amount required to hold the model inverted, the model now has equal travel available from level upright or level inverted.)

Exponential: changes the response curve of the servos relative to the stick position to make flying more pleasant. You can make the servo movement less or more sensitive around neutral for rudder, aileron, elevator, and throttle (except **HELI** type - use **THROTTLE CURVE** instead). (**ACRO** type—throttle EXP and THROTTLE CURVE can not be activated simultaneously. Why use expo? Many models require a large amount of travel to perform their best tricks. However, without exponential, they are "touchy" around neutral, making them unpleasant to fly and making small corrections very difficult. Additionally, by setting different exponentials for each rate, you can make the effectiveness of small corrections similar in each rate, as in our example below.

The best way to understand exponential is to try it:

- Having made no changes yet in the **D/R,EXP** screen, move **SWITCH D** to "down" (toward the **AILERON STICK**).
- Cursor down to **EXP** and dial to +100%.
- Move **SWITCH D** up. Hold the **AILERON STICK** at 1/4 stick and move **SWITCH D** down.
- Notice how much less travel there is.
- Go to 3/4 stick and repeat. Notice how the travel is much closer, if not identical.

Adjustability:

- More sensitive around neutral. (positive exponential, see example)
- Less sensitive around neutral. (negative exponential, see example)
- Adjustable for each direction. (**ACRO/GLID**)

For throttle, exponential is applied at the low end to help nitro and gasoline engines have a linear throttle response, so that each 1/4 stick increases engine RPM 25% of the available range. (In most engines this ranges from 5-60%.)

Special note for helicopters: Helicopter model types have just a single rate for each switch position rather than a rate for each side of the servo’s travel per switch position. Additionally, setting the **D/R,EXP** for each switch position requires cursoring back to the **No.** setting and changing the switch position here. Just flipping the switch does not affect the screen setting, allowing dual rates to be assigned with idle-up and other features on certain switches, and does not require putting the model in that condition to make modifications.

Special note for conditions: The helicopter and glider programming offers you the choice of **Cond.** This option allows you to have a separate rate for each of the 3 controls automatically selected when changing conditions, for a total of FIVE rates available.

Simply change the switch choice to **Cond.** and then:

(HELI) press the **CURSOR LEVER** to toggle through the 5 conditions while setting the rates.

(GLID) activate the corresponding condition to edit the rates.

GOAL of EXAMPLE:	STEPS:	INPUTS:
Set up dual rates and exponential in a HELI model.	Open D/R,EXP .	(MODE) for 1 second. (If ADVANCE , (MODE) again.) ⬅️ to D/R,EXP . ⚙️
	Choose channel.	⬅️ to desired channel.
	Choose first switch position.	⬅️ to No> . ⚙️ to UP .
	Set rate and exponential (Ex: high rate = 95%, 0% exponential.)	⬅️ to D/R> . ⚙️ to 95% . Confirm 0% EXP .
	Go to 2nd switch position and set rate and exponential.	⬅️ to No> . ⚙️ to DN . Repeat above.
	<i>Optional: if using a 3 position switch, set 3rd rate.</i>	⬅️ to No> . ⚙️ to CT . Repeat above.
	<i>Optional: assign dual rates to have one for each condition.</i>	⬅️ to SW . ⚙️ to COND . Repeat steps above to adjust for each condition.

GOAL of EXAMPLE:	STEPS:	INPUTS:
Set up aileron triple rates on SWITCH C with travel settings of 75% (normal), 25% (slow roll) and 140% (extreme aerobatics) and exponential settings of 0%, +15%, and -40% respectively.	Open D/R,EXP function.	for 1 second. (If ADVANCE , again.)
	Choose the channel to change (Ex: aileron is already selected)	to D/R,EXP .
	<i>Optional: change switch assignment.</i>	to SW1 . to C .
NOTE: This normal rate has no exponential so it has a very linear, normal feel. This slow roll rate has positive exponential (the opposite of what most people normally use), which makes the servos more responsive around center. This makes the servos feel the same around center in the normal and low rates, but still gives a very slow roll rate at full stick.	Confirm switch is in desired position and set rate. (Ex: up = high rate, 75%).	to D/R> . C to up position. AILERON STICK . to 75%. AILERON STICK . to 75%.
	Move SWITCH to 2nd rate position and set this particular rate. (Ex: center = low rate, 25%).	C to center position. AILERON STICK . to 25%. AILERON STICK . to 25%.
	<i>Optional: if using a 3 position SWITCH, move SWITCH to 3rd position and set this rate (Ex: down = 3D rate, 140%).</i>	C to down position. AILERON STICK . to 140%. AILERON STICK . to 140%.
The 3D rate (extreme aerobatics) has a very high distance of travel B nearly twice that of the normal rate. Therefore, using a very high negative exponential setting softens how the servos respond around center stick. This makes the servos respond similarly around center stick for a more comfortable feel.	Optional: instead of using a switch, you can set high rates to be triggered when the stick moves past a certain point. To test this, set aileron high rate to 25%. Now set switch assignment to AIL (90%). Move AILERON STICK to the right and notice the huge jump in travel after the stick moves 90% of its distance.	to SW1 . to AIL (90%) . to D/R> . AILERON STICK . to 25%. AILERON STICK . to 25%. AILERON STICK and watch screen graph. See the change?!
Many modelers like to set up all 3 triple rates on a single 3-position switch, creating a “slow and pretty mode”, a “normal mode”, and a “wild stunts mode” all with the flip of a single switch. To do so, simply set up rates for all 3 controls and assign all 3 to the same 3-position switch.	Set each rate's EXP . (Ex: 0%, +15%, -40%)	to EXP> . C to up position. Confirm EXP reads 0. C to down position. AILERON STICK . to +15%. AILERON STICK . to +15%. C to center position. repeat to set low rate expo to -40%.
	<i>Repeat above steps for elevator and rudder.</i>	
	Close.	
Where next?	Set up flight timers: see p.33. Set up TRAINER functions: see p. 34. Adjust the sensitivity of the trims: see p. 36. Set up twin aileron servos: see p. 39. Set up twin elevator servos: see p. 44. Set up programmable mixes to meet your specific needs: see p. 47.	

TIMER submenu (stopwatch functions): controls three electronic clocks used to keep track of time remaining in a competition time allowed, flying time on a tank of fuel, amount of time on a battery, etc.

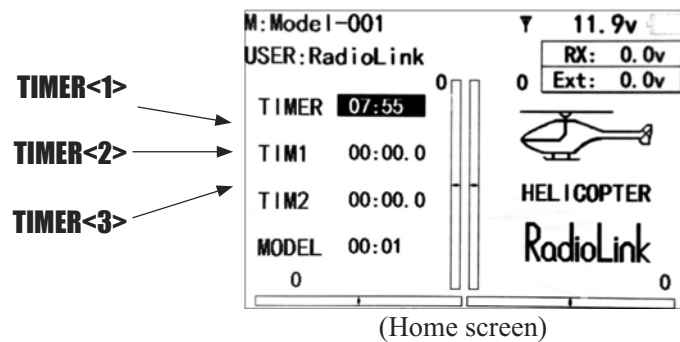
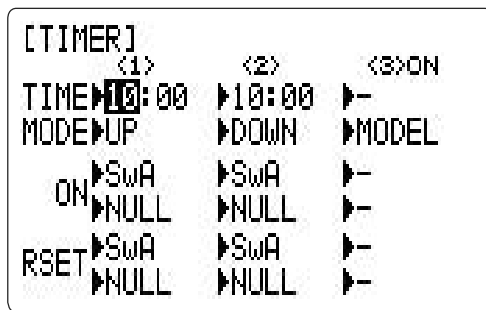

Adjustability:

- Count down timer: starts from the chosen time, displays time remaining. If the time is exceeded, it continues to count below 0.
- Count up timer: starts at 0 and displays the elapsed time up to 99 minutes 59 seconds.
- Count down timer (Stop type): starts from the chosen time, displays time remaining, and stops at 0.
- Model timer: cumulates ON time up to 99 hours 59 minutes each model. Once Model timer function is turned off, the cumulate time will also be reset to "0:00".
- Independent to each model, and automatically updates with model change.
- In either **TIMER** mode, the timer beeps once each minute. During the last twenty seconds, there's a beep each two seconds. During the last ten seconds, there's a beep each second. A long tone is emitted when the time selected is reached. (UP/DOWN **TIMER**)
- To Reset, choose the desired timer with the **CURSOR** lever (while at the startup screen), then press and hold **DIAL** for 1 second.
- Activation by either direction of **SWITCH A-H**, by **THROTTLE STICK (STK-THR)** (Using the **THROTTLE STICK** is convenient if you are keeping track of fuel remaining, or for an electric, how much battery is left), by **LOGIC SWITCH Lsw1-Lsw3** or by the power SWITCH (**PWR SW**). Set up **LOGIC SW**: See p. 38.
- Also the reset switch can be assigned (**SWITCH A-H** or **LOGIC SWITCH Lsw1-Lsw3**)

GOAL of EXAMPLE:	STEPS:	INPUTS:
Set timer 2 to count down 4-1/2minutes, being controlled by THROTTLE STICK position. This is utilized to keep track of actual Throttle on time to better correlate with fuel/battery usage.	Open BASIC menu, then open TIMER function.	(MODE) for 1 second. (If ADVANCE , (MODE) again.) ⊙ to page 2. ⊙ to TIMER . ⊙
	Go to TIMER<2> .	⊙ to 10 (TIMER<2>).
	Adjust time to 4 min. 30 sec., count down.	⊙ to 4 . ⊙ to 00 (TIMER<2>). ⊙ to 30.
	Assign to THROTTLE STICK and set trigger point.	⊙ to ON>SWA (TIMER<2>). ⊙ to STK THR . ⊙ to 50% . ⊙ for 1 second to NULL . ⊙ THROTTLE STICK to desired position (Ex: 1/4 stick). ⊙ for 1 second to set.
	Close.	(END) (END)
<i>Where next?</i>	Adjust END POINTS after first flight test: see p. 27. Adjust auxiliary channel assignments (ex: move flaps to a switch): see p. 34. Set up TRAINER functions: see p. 34.	

Auxiliary channel function (including channel 9-10 controls)(AUX-CH): defines the relationship between the transmitter controls and the receiver output for channels 5-10. Also, the **CH9-10 POSI** are used to change the CH9-10 servo direction.

```
[AUX-CH SELECT]
CH5 SWA
CH6 VrA
CH7 VrC
CH8 VrB (Sx05)
CH9 SWB POSI DOWN
CH10 SWA POSI DOWN
```

Adjustability:

- channels 5-8 may be assigned to any **SWITCH (A-H)**, **LOGIC SWITCH (Lsw1-Lsw3)**, slider [**VR(D)** and **VR(E)**], or knob [**VR(A-C)**] (for example, moving flaps to a switch or slider), but not the primary control sticks (use programmable mixes to do so, p. 68);
- channel 9-10 may be assigned to any **SWITCH (A-H)**, **LOGIC SWITCH (Lsw1-Lsw3)** and the servo direction may be changed.
- multiple channels may be assigned to the same switch, slider or knob;
- channels set to "NULL" are only controlled by mixes. (Ex: utilizing 2 channels for 2 rudder servos. See mixes, p. 68.)
- If **GYRO SENSE**, **GOVERNOR**, and **THR-NEEDLE** functions are activated, **AUX-CH** settings of related channels become invalid automatically.

Related channels:

GYRO SENSE (ACRO): ch. 5, 7, or 8: see p. 56.

GYRO SENSE (HELI): ch. 5: see p. 85.

GOVERNOR (HELI): ch. 7, or ch. 7 and 8: see p. 86.

THR-NEEDLE (ACRO/HELI): ch. 8: see p. 50.

⚠ Remember that if you assign primary control of a channel to a switch which you later use for other functions (like dual/triple rates or airbrakes), every time you use that other function you will also be moving the auxiliary channel.

GOAL of EXAMPLE:	STEPS:	INPUTS:
Assign flaps to the right slider [VR(E)] and set channel 7 to NULL in preparation to use it as a smoke system control (the smoke system being activated later by a throttle-to-ch.-7 mix).	Open BASIC menu, then open AUX-CH function.	for 1 second. (If ADVANCE , again.) to AUX-CH .
	Choose the channel to change. (ex: ch. 6.)	to Ch 7 .
	Change primary control. (ex: to slider.)	to Vr-E .
	Repeat as needed. (ex: ch. 7 to NULL .)	to Ch 7 . to NULL .
	Close.	
<i>Where next?</i>	Programmable mixes: see p. 68. Set up dual/triple rates and exponential (D/R,EXP): see p. 30. Adjust SUB-TRIM of auxiliary channel to adjust center SWITCH position: see p. 36. Adjust END POINTS (sets end points of travel even when using a switch): see p. 27.	

TRAINER: for training novice pilots with optional trainer cord connecting 2 transmitters. The instructor has several levels of controllability.

```
[TRAINER]
1:AILE FUNC
2:ELEV FUNC
3:THRO FUNC
4:RUDD FUNC
5:GEAR OFF
6:FLAP OFF
7:AUX1 OFF
8:AUX2 OFF
▶INH
CH1:AILERON
▶FUNC
```

Adjustability:

• **NORM:** When the **TRAINER SWITCH** is ON, the channel set to this mode can be controlled by the student. The set channel is controlled according to any programming set at the student's transmitter.

• **FUNC:** When the **TRAINER SWITCH** is ON, the channel set to this mode can be controlled by the student, controlled according to any mixing set at the instructor's transmitter.

- **MIX:** When the **TRAINER SWITCH** is ON, the channel set to this mode can be controlled by both the student and the instructor, controlled according to any mixing set at the instructor's transmitter. And the student's mixing rate is adjustable. (default 30%)

[Note] However, it becomes invalid even if it sets up the channel which is not in a student's transmitter. The channel serves as operation by the instructor's transmitter automatically.

- **OFF:** The channel set to this mode cannot be controlled by the student even when the **TRAINER SWITCH** is ON. The set channel is controlled by the instructor only, even when the **TRAINER SWITCH** is ON.
- **SWITCH:** controlled by spring-loaded **SWITCH** only. Not assignable.
- **Compatibility:** The AT10 may be master or student with any Radiolink transmitter compatible with the cord. Simply plug the optional trainer cord (For AT10 series, sold separately) into the trainer connection on each transmitter, and follow the guidelines below.

Examples:

- When throttle/collective are set to **FUNC**, 5-channel helicopter practice is possible with a 4-channel transmitter.
- Set up the model in a second transmitter, use **NORM** mode to quickly and safely check proper operation of all functions, then allow the student radio to fully fly the model.
- Using **NORM** mode, set lower throws, different exponentials, even different auxiliary channel settings on the student radio (if it has these features).
- To ease the learning curve, elevator and aileron may be set to the **NORM** or **FUNC** mode, with the other channels set to OFF and controlled by the instructor.

Precautions:

- NEVER turn on the student transmitter power.
- ALWAYS set the student transmitter modulation mode to **PPM**.
- BE SURE that the student and instructor transmitters have identical trim settings and control motions. Verify by switching back and forth while moving the control sticks.
- FULLY extend the instructor's antenna. Collapse the student's antenna. (except 2.4GHz)
- When the **TRAINER** function is active, the snap roll function is deactivated. Other functions, such as **IDLE-DOWN** and **THR-CUT**, which have been assigned to the same switch, are not deactivated. Always double check your function assignments prior to utilizing the **TRAINER** function.
- When you select a different model, the **TRAINER** function is deactivated in the current model for safety reasons.

GOAL of EXAMPLE:	STEPS:	INPUTS:
Turn on the TRAINER system and set up so student has: fully functional control of aileron and elevator to support FLAPERON and AILEVATOR ; normal control of rudder to allow lowered travel; and no throttle channel control (with the instructor for safety).	Open BASIC menu, then open TRAINER function.	(MODE) for 1 second. (If ADVANCE , (MODE) again.)
	Activate TRAINER .	(TRAINER) to OFF .
	Choose desired channel(s) and proper training type(s).	(TRIM) past AIL and ELE (default OK). (TRIM) to THR , (TRAINER) to OFF . (TRIM) to RUD , (TRAINER) to NORM .
	Close.	(END) (END)
	TEST student radio function fully prior to attempting to fly!	
Where next?	Set up dual/triple rates and exponential (D/R,EXP) on student AT10: see p.30. Reset trims on student AT10: see p. 35.	

TRIM submenu: resets and adjust effectiveness of digital trims.

```
[TRIM]
RESET ▶ Execute
STEP  AILE▶ 4 (< 0)
      ELEV▶ 4 (< 0)
      THRO▶ 4 (< 0)
      RUDD▶ 4 (< 0)
```

The AT10 has digital trims which are different from conventional mechanical trim sliders. Each **TRIM LEVER** is actually a two-direction switch. Each time the **TRIM LEVER** is pressed, the trim is changed a selected amount. When you hold the **TRIM LEVER**, the trim speed increases. The current trim position is graphically displayed on the start up screen. The **TRIM** submenu includes two functions that are used to manage the trim options.

HELI models only: **OFFSET** is available in the idle ups. If **OFFSET** is inhibited, adjustment of the **TRIM LEVERS** will adjust the trims for all flight conditions. If **OFFSET** is active, then moving the trims within any one condition will effect only that condition. See **OFFSET**, p. 81.

Trim reset (RESET): electronically centers the trims to their default values. Note that the **SUB-TRIM** settings and the trim **STEP** rate are not reset by this command.

GOAL of EXAMPLE:	STEPS:	INPUTS:
Reset trims to neutral after having adjusted all linkages. NOTE: This is one of several functions for which the radio requires confirmation to make a change.	Open BASIC menu, then open TRIM submenu.	(MODE) for 1 second. (If ADVANCE , (MODE) again.) ◂ to TRIM . ☀
	Request <i>and confirm the reset</i> .	☀ for 1 second. Beep sounds.
	Close.	(END) (END)
<i>Where next?</i>	Adjust SUB-TRIMS : see p. 36. Adjust trim rate (STEP): see below. Adjust END POINTS : see p. 27. Set up dual/triple rates and exponential (D/R,EXP): see p. 30.	

Trim step (STEP): changes the rate at which the trim moves when the **TRIM LEVER** is activated. It may be set from 1 to 40 units, depending on the characteristics of the aircraft. Most ordinary aircraft do well at about 2 to 10 units. Generally larger trim steps are for models with large control throws or for first flights to ensure sufficient trim to properly correct the model. Smaller trim steps are later used to allow very fine adjustments in flight.

GOAL of EXAMPLE:	STEPS:	INPUTS:
Double the sensitivity (larger step) of the AILERON TRIM LEVERS for a first flight of an aerobatic model to ensure sufficient range to trim the model for level flight.	Open TRIM submenu and choose the STEP you wish to change. (Ex: aileron)	(MODE) for 1 second. (If ADVANCE , (MODE) again.) ◂ to TRIM . ☀
	Adjust the size of the step. (Ex: incr. to 8)	◂ to AILE . ☀ to 8 .
	Repeat as desired for other channels.	◂ to ELEV . ☀ to new setting. Repeat as needed.
	Close.	(END) (END)
<i>Where next?</i>	Adjust sub trims: see p. 36. Adjust END POINTS : see p. 27. Set up dual/triple rates and exponential (D/R,EXP): see p. 30.	

SUB-TRIM: makes small changes or corrections to the neutral position of each servo. Range is -120 to +120, with 0 setting, the default, being no **SUB-TRIM**.

[SUB-TRIM]	+1: AILE	0
	2: ELEV	0
	3: THRO	0
	4: RUDD	0
CH1: AILERON	5: GEAR	0
█ 0	6: FLAP	0
	7: AUX1	0
	8: AUX2	0

We recommend that you center the digital trims before making **SUB-TRIM** changes, and that you try to keep all of the **SUB-TRIM** values as small as possible. Otherwise, when the **SUB-TRIMS** are large values, the servo's range of travel is restricted on one side.

The recommended procedure is as follows:

- measure and record the desired surface position;
- zero out both the trims (**TRIM RESET** menu) and the **SUB-TRIMS** (this menu);
- mount servo arms and linkages so that the control surface's neutral is as correct as possible; and
- use a small amount of **SUB-TRIM** to make fine corrections.

GOAL of EXAMPLE:	STEPS:	INPUTS:
Adjust the flap servo's SUB-TRIM until its center exactly matches the aileron servo's center, as they are to work together as flaperons.	Open BASIC menu, then open SUB-TRIM .	(MODE) for 1 second. (If ADVANCE , (MODE) again.) ⬇️ to SUB-TRIM . 🌞
	Choose the channel to adjust, and adjust until surfaces match. (Ex: flap)	⬇️ to FLAP 🌞 as needed. ⬇️ to each channel,
	Repeat for other channels.	🌞 as needed.
	Close.	(END) (END)
Where next?	Adjust trim steps: see p. 35. Adjust END POINTS : see p. 27. Set up dual/triple rates and exponential (D/R,EXP): see p. 30.	

SERVO display and cycle submenu: displays radio's output to channels 1-10.

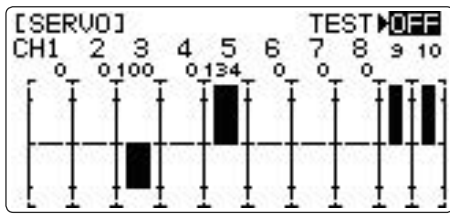

The servo submenu includes two features:

- real-time bar-graph display to demonstrate exactly what commands the transmitter is sending to the servos. (This can be particularly handy in setting up models with complicated mixing functions, because the results of each stick, lever, knob, switch input and delay circuit may be immediately seen.)
- servo cycle function to help locate servo problems prior to in-flight failures. (channels 1-8)

GOAL of EXAMPLE:	STEPS:	INPUTS:
View the result of reassigning channel 6 from VR(A) knob to three-position SWITCH C . Cycle the channel 6 servo.	Complete desired programming function. (Ex: in AUX-CH , move ch. 6 to SWITCH C)	See AUX-CH for details. (p. 34.)
	Open the SERVO function.	(MODE) for 1 second. (If ADVANCE , (MODE) again.) ⬇️ to SERVO . 🌞
	Move each control to see exactly how operating. (Ex: SWITCH C in all positions)	⬆️ C to center position. Note change in position of ch. 6 servo.
	Prepare all servos to be cycled and cycle.	Plug in servos. POWER ON . 🌞
	End cycling and close.	(END) (END)
Where next?	Set up dual/triple rates and exponential (D/R,EXP): see p. 30. Set up desired programmable mixes: see p. 47. Set up dual aileron servos: see p. 39. Set up dual elevator servos: see p. 44.	

FailSafe (loss of clean signal and low receiver battery) submenu (F/S): sets responses in case of loss of signal or low Rx battery

FailSafe (F/S): instructs a 2.4G receiver what to do in the event radio interference is received.

[F/S]		
	→ 1:	AILE NOR
	2:	ELEV NOR
CH1: AILE	3:	THRO 25%
NOR F/S	4:	RUDD NOR
	5:	GYRO NOR
	6:	PITC NOR
	7:	AUX1 NOR
	8:	AUX2 NOR







Adjustability:

- Each channel may be set independently.
- The **NOR** (normal) setting holds the servo in its last commanded position.
- The **F/S** (FailSafe) function moves each servo to a predetermined position.
- **NOTE:** the setting of the throttle's **F/S** also applies to the Battery **F/S** (see below).

Examples:

- The **F/S** setting is used in certain competitions to spin the aircraft to the ground prior to flying away and doing potential damage elsewhere. Conversely, may also be used to go to neutral on all servos, hopefully keeping the plane flying as long as possible.
- Competition modelers often maintain the **NOR** function so that brief interference will not affect their model's maneuver.
- Set the throttle channel so that the engine idles when there is interference (**ACRO**). This may give enough time to fly away from and recover from the radio interference and minimize damage if crashed.
- For helicopters, **NOR** is typically the safest choice.
- We also recommend setting a gasoline engine's electronic kill switch to the OFF position in the **F/S** function for safety reasons.

Updating F/S Settings: If you specify a **F/S** setting, the FailSafe data is automatically transmitted once each two minutes. (**PCM**) When you choose the **F/S** mode, check that your settings are as desired by turning off the transmitter power switch and verifying that the servos move to the settings that you chose. Be sure to wait at least two minutes after changing the setting and turning on the receiver power before turning off the transmitter to confirm your changes have been transmitted.

GOAL of EXAMPLE:	STEPS:	INPUTS:
Change the receiver FailSafe command for channel 8 (gasoline engine kill switch) to a preset position. <i>NOTE: This is one of several functions for which the radio requires confirmation to make a change.</i>	Open the BASIC menu, then open F/S function.	(MODE) for 1 second. (If ADVANCE , (MODE) again.)  to F/S . 
	Choose Channel to change. (ex: Ch. 8)	 to Ch 8.
	Set and confirm fail safe command.	  that controls channel 8 to desired OFF position.   for 1 second to store.
	Repeat as desired.	
	Close.	(END) (END)
<i>Where next?</i>	Wait two minutes and confirm F/S settings as described above. Read below for information on Battery FailSafe. Adjust END POINTS to gain proper F/S responses if needed: see p. 27. Adjust SUB-TRIM to gain proper F/S responses if needed: see p. 36.	

LOW BATTERY ALARM

Extended by ESC power sensor, R10D can set a low voltage alarming by the following steps: on basic menu, enter parameter and change RX alarm.

Battery FailSafe (F/S): a second battery low warning feature (separate from the transmitter low voltage warning). When the airborne battery voltage drops below approximately 3.8V, the 2.4G receiver's battery **F/S** function moves the throttle to a predetermined position. When the Battery **F/S** function is activated, your engine will move to idle (if you haven't set a position) or a preset position. You should immediately land. You may temporarily reset the Battery **F/S** function by moving the **THROTTLE STICK** to idle. You will have about 30 seconds of throttle control before the battery function reactivates.

Adjustability:

- **NOR F/S** setting for throttle results in Battery **F/S** going to the servo position reached by moving **THROTTLE STICK** to the bottom with **TRIM LEVER** centered;
- **F/S** position setting for throttle results in Battery **F/S** also going to the same throttle servo position as the regular **F/S**.

⚠ If using a 6V (5-cell) receiver battery, it is very likely that your battery will be rapidly running out of charge before battery FailSafe takes over. It is not a good idea to count on battery FailSafe to protect your model at any time, but especially when using a 5-cell battery.

ACRO ADVANCE MENU FUNCTIONS:

Aircraft wing types (ACRO/GLID):

There are 3 basic wing types in aircraft models:

- Simple. Model uses one aileron servo (or multiple servos on a Y-harness into a single receiver channel) and has a tail. This is the default setup and requires no specialized wing programming.
- Twin Aileron Servos. Model uses 2 aileron servos and has a tail. see Twin Aileron Servos.
- Tail-less model (flying wing). Model uses 2 wing servos working together to create both roll and pitch control. see **ELEVON**.

Twin Aileron Servos (with a tail) (ACRO/GLID): Many current generation models use two aileron servos, plugged into two separate receiver channels. (If your model is a flying wing without separate elevators, see **ELEVON**, p. 43.)

Benefits:

- Ability to adjust each servo's center and end points for perfectly matched travel.
- Redundancy, for example in case of a servo failure or mid-air collision.
- Ease of assembly and more torque per surface by not requiring torque rods for a single servo to drive 2 surfaces.
- Having more up aileron travel than down travel for straighter rolls . aileron differential. (see glossary for definition.)
- Using the two ailerons not only as ailerons but also as flaps, in which case they are called flaperons.
- Set a negative percentage to reverse the operation of one of the servos.

Options:

• 5-channel receiver. Set up **AILE-2** (see p. 42) prior to continuing with **FLAPERON** or **AIL-DIFF**.

• **FLAPERON:**

- Uses CH6 for the second servo (see **AIL-2** to use CH5.)
- Allows flap action as well as aileron action from the ailerons.
- Provides **FLAP-TRIM** function to adjust the neutral point of the flaperons for level flight.
- Also allows aileron differential in its own programming (instead of activating **AIL-DIFF**).

• Aileron Differential (**AIL-DIFF**):

- Uses CH7 for the 2nd servo (see **AIL-2** to use CH5.)
- Leaves CH5 & CH6 free for flap operation, such as flaperon and flap action together, in **AIRBRAKE**. (see p. 48).
- Allows for more up aileron travel than down for straighter rolls.

You will need to choose which of **FLAPERON** or **AIL-DIFF** is the better choice for your model's setup. If you need the ailerons to also operate as flaps, you most likely want to use **FLAPERON**. If your model has 2 aileron servos and flaps, then **AIL-DIFF** is probably the easiest choice.

NOTE: Only one of the three wing-type functions (**FLAPERON**, **AIL-DIFF**, and **ELEVON**) can be used at a time. All three functions cannot be activated simultaneously. To activate a different wing type, the first must be deactivated.

GOAL of EXAMPLE:	STEPS:	INPUTS:
De-activate FLAPERON so that AIL-DIFF or ELEVON can be activated.	Open the FLAPERON function.	(MODE) for 1 second. (If BASIC , (MODE) again.) ⊙ to FLAPERON . ☀
	De-activate the function.	⊙ to MIX . ☀ to INH .
	Close function.	(END) (END)
Where next?	Set up AILE-DIFF (see p. 41) or ELEVON (see p. 43).	

*Using **FLAPERON (ACRO/GLID 1A+1F)**:*

[FLAPERON]
MIX: INH
(L) (R)
RATE-AIL1: +100% +100%
AIL2: +100% +100%
FLP2: +100% +100%
FLP1: +100% +100%

(ACRO)

[FLAPERON]
MIX: INH
(L) (R) NORMA
RATE-AIL1: +100% +100% START
AIL2: +100% +100% SPEED
FLP2: +100% +100% DISTA
FLP1: +100% +100% LAND 1
B. FLY-ADJ: 25%

(GLID 1A+1F)

The **FLAPERON** mixing function uses one servo on each of the two ailerons, and uses them for both aileron and flap function. For flap effect, the ailerons raise/lower simultaneously. Of course, aileron function (moving in opposite directions) is also performed.

*[Note] When changing the polarity of a rate, "change rate dir?" is displayed for a check. Please set up after pressing **DIAL** for 1 second and canceling an alarm display. (GLID only)*

Once **FLAPERON** is activated, any time you program CH6 or "flap" (i.e. **ELEVATOR-FLAP** mixing), the radio commands both servos to operate as flaps. The amount of travel available as flaps is independently adjustable in **FLAPERON**. A trimming feature is also available (see **FLAP-TRIM**) to adjust both neutral positions together for straight-and-level flight or slight increases/decreases of the flap angle. **END POINT** and **SUB-TRIM** both still adjust each servo individually.

Adjustability:

- Each aileron servo's up travel can be set separate from its down travel, creating aileron differential. (See example).
- Each aileron servo's travel when actuated as a flap is separately adjustable.
- **AILE-2** can be utilized to use a 5-channel receiver and still have flaperons. NOTE: The **AILE-2** function only commands the channel 5 servo to operate with the aileron servo as ailerons, and to obey the primary flap control (travel adjusted in **FLAP-TRIM**.) It does not provide full flap mix capability as when using a 6+ channel receiver and channel 6.
- The separate **FLAPERON** settings for each condition can be set. (**GLID**)

NOTE: Activating flaperons only makes the ailerons work as ailerons and tells the radio how far you want them to move as flaps. IF you then activate other programming that moves them as flaps.

FLAP-TRIM is the flap-trimming feature that allows the flaps to move in reaction to the channel 6 control. It is meant only for trimming the flaps' center but can also be used as full flap control. (See p. 40.)

AIRBRAKE is a feature that drops flaperons as flap, and also compensates with elevator if desired. (See p. 48.)

ELEVATOR-FLAP would add elevator mixing into the flap movement from the flap dial after **FLAP-TRIM** is activated.

GOAL of EXAMPLE:	STEPS:	INPUTS:
Activate twin aileron servos, FLAPERON .	Open the FLAPERON function.	MODE for 1 second. (If BASIC , MODE again.) ⬆️ to FLAPERON . ⚙️
Input 10% less down travel than up travel (aileron differential) within the FLAPERON programming. (Decrease right aileron is down travel to 90%, decrease left aileron's down travel to 90%.)	Activate the function.	⬆️ to MIX . ⚙️ to ACT .
Adjust total flap travel available to 50% of aileron travel available.	<i>Optional: adjust the up/down travel separately for the 2 servos. (Ex: 90% down.)</i>	⬆️ to AIL1 . ⚙️ AILERON STICK . ⚙️ to 90% . ⬆️ to AIL2 . ⚙️ AILERON STICK . ⚙️ to 90% .
	<i>Optional: adjust the aileron's travel so they move as flaps. (Ex: each servo flap travel to 50%.)</i>	⬆️ to FLP2 . ⚙️ to +50% . ⬆️ to FLP1 . ⚙️ to -50% .
	Close menu.	END END
<i>Where next?</i>	Set FLAP-TRIM : see p. 40. Set up AIRBRAKE mix: see p. 48. Mix flaperon's flap motion to another inboard flap (plugged into aux1): see p.47. Welcome to click our web for more.	

* If you receive an error message that OTHER WING MIXING IS ON, you must deactivate **AIL-DIFF** or **ELEVON**. see p. 41.

Using **FLAP-TRIM** (camber) to adjust flaperons: (**ACRO/GLID**)

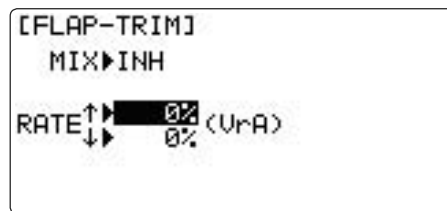
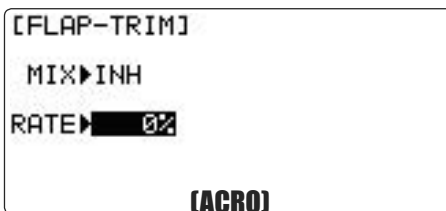

FLAP-TRIM assigns the primary flaperon control [defaults to **VR(A)**] to allow trimming in flight of the flap action of flaperons. (Note: even if **FLAP-TRIM** is made active with **AIL-DIFF**, it will not have any effect. The **ONLY** function that allows control of the ailerons as flaps in the **AIL-DIFF** configuration is **AIRBRAKE**.) Most modelers use **AIRBRAKE**, or programmable mixes, to move the flaps to a specified position via movement of a switch.

FLAP-TRIM may also be used as the primary flap control in flight. By doing so, you can assign CH6 to a 3-position switch, with a "spoileron", neutral, and "flaperon" position, and even adjust the percentage traveled as flaperon/spoileron by changing the Flap Trim travel. (Note that there is only one setting, not independent settings for up and down travel.)

GOAL of EXAMPLE:	STEPS:	INPUTS:
Add FLAP-TRIM to allow the model's ailerons to be trimmed together as flaps at any time during the flight, with a maximum travel of 5% of the total flap travel set in FLAPERON .	Open the FLAP-TRIM function.	(MODE) for 1 second. (If BASIC , (MODE) again.) ⊙ to FLAP-TRIM . ⚙
	The function is automatically activated with FLAPERON ; however, the default travel is 0 .	
	Adjust the travel available to the flaperons when turning the CH6 DIAL . (Ex: 5%).	⚙ to 5% .
	Optional: Use as total flap control. Reassign CH6 is primary control in AUX-CH to your desired flap control. (Ex: right slider)	⚙ to 50% . (END) (MODE) ⊙ to AUX-CH . ⚙ ⊙ to CH6 . ⚙ to Vr-E .
	Close menu.	(END) (END)
<i>Where next?</i>	Adjust individual servo's SUB-TRIMS : see p. 36 and END POINTS : see p. 27. Set up AIRBRAKE mix: see p. 48 and ELEV-FLAP mix: see p. 48. Mix flaperon's flap movement to an additional inboard flap (plugged into aux1): see p. 47.	

Using Aileron Differential (AILE-DIFF)(ACRO/GLID 2A+1F/GLID 2A+2F):

```
[AILE-DIFF]
MIX▶INH
          (L) (R)
RATE-AIL1▶+100% +100%
      AIL2▶+100% +100%
FLAP▶CH6
```

(ACRO)

```
[AILE-DIFF]
          (L) (R)
RATE-AIL1▶+100% +100%
      AIL2▶+100% +100%
          NORML←
          START
          SPEED
          DISTA
          LANDI
B.FLY-ADJ▶ 25%
```

(GLID 2A+1F/GLID 2A+2F)

Aileron differential is primarily used on 3 or 4-servo wings, with one servo(s) operating inboard flap(s) on CH6 or CH5 & CH6, and **AILE-DIFF** controlling proper aileron operation of 2 aileron servos, plugged into CH1 and CH7. The ailerons can not be moved like flaps when using **AILE-DIFF**, except if using **AIRBRAKE** (see p. 63.) (Note that even if you make **FLAP-TRIM** active while using **AILE-DIFF**, it will not have any effect. ONLY **AIRBRAKE** controls the ailerons as flaps in the **AILE-DIFF** configuration .)

*[Note] When changing the polarity of a rate in camber-flap, "change rate dir?" is displayed for a check. Please set up after pressing **DIAL** for 1 second and canceling an alarm display. (GLID only)*

- FLAP function allows you to set up 1 or 2 servos for flap action.
- The separate **AILE-DIFF** settings for each condition can be set. (GLID only)

GOAL of EXAMPLE:	STEPS:	INPUTS:
Activate twin aileron servos using AIL-DIFF. Note that the function defaults to no difference in down travel vs. up travel. If you want differential travel, simply adjust each side. (Ex: 90%)	Open the AIL-DIFF function.	(MODE) for 1 second. (If BASIC , (MODE) again.) ⬅️ to AIL-DIFF . ☀️ *
	Activate the function.	⬅️ to MIX . 🕒 to ACT .
	Optional: adjust the up/down travel separately for the 2 servos. (Ex: adjust to 90% .)	⬅️ to AIL1 . 🕒 AILERON STICK . 🕒 to 90% . ⬅️ to AIL2 . 🕒 AILERON STICK . 🕒 to 90% .
	Close menu.	(END) (END)
Where next?	Adjust individual servo's SUB-TRIMS : see p. 36 and END POINTS : see p. 27. Set up AIRBRAKE mix: see p. 48. Set up ELEV-FLAP mix (only if model has a flap servo in CH6): see p. 48. Set up SNAP-ROLL Function: see p. 45. View additional model setups: www.radiolink.com.cn/doce/	

*If you receive an error message that **OTHER WING MIXING IS ON**, you must deactivate **ELEVON** or **FLAPERON**. See p. 43.

Using Twin Aileron Servos with a 5-channel receiver, **AILE-2 (ACRO/GLID)** :

[PARAMETER]

RESET: Execute

TYPE: **ACROBASIC**

SWASH: H-1

ATL: ON

RX ALARM: 4.6V BACK MAX: 11

BACKCOL. OR: BLUE LIGHT MIN: 9

HOME-DISP: THR/PIT USER NAME: Rad.i.o.l.i.n.k

AILE-2 allows **FLAPERON** and **AIL-DIFF** with a 5-channel receiver. **AILE-2** only tells the radio that you are using CH5 and CH6 (**FLAPERON**), or CH5 and CH7 (**AIL-DIFF**), not CH6 or CH7, as the second servo in **FLAPERON** or **AIL-DIFF**. You still must activate and set up the **FLAPERON/AILE-DIFF** function.

Note that selecting **CH6&5** or **CH7&5** does NOT free up CH6 or CH7 to be used for other functions when using a receiver with more than 5 channels. Both 5 and 6 (**FLAPERON**)/7 (**AIL-DIFF**) are dedicated to the **FLAPERON** or **AIL-DIFF** programming. [This is beneficial with four aileron servos that need to have their end points or sub-trims set separately. CH1, CH5 and CH6 are already fully set up to operate as ailerons. Mix CH7 or CH8 (the second aileron servo on the other side) into ailerons to function properly.]

Aircraft tail types (**ACRO/GLID**):

GOAL of EXAMPLE:	STEPS:	INPUTS:
Adjust the second aileron servo output from CH6or7 to channels CH6&5 . Allows twin aileron servo operation with a 5-channel receiver.	Open the PARAMETER submenu.	(MODE) for 1 second. (If ADVANCE , (MODE) again.) ⬅️ to PARAMETER . ☀️
	Select AILE-2 and change to CH6&5 .	⬅️ to AILE-2 . 🕒 to CH6&5 .
	Close menu.	(END) (END)
Where next?	Finish setting up FLAPERON or AIL-DIFF . see Twin Aileron Servos: p. 39. View additional model setups on the internet: www.radiolink.com.cn/doce/	

There are 4 basic tail types in aircraft models:

- Simple. Model uses one elevator servo and one rudder servo (or multiple servos on a Y-harness). This is the default.
- Dual Elevator servos. Model uses 2 elevator servos. see **AILEVATOR (ACRO)** see p. 44.
- Tail-less model. Model uses 2 wing servos together to create roll and pitch control. see **ELEVON(ACRO/GLID 1A+1F)**. see p. 43.
- **V-TAIL**. Model uses 2 surfaces, at an angle, together to create yaw and pitch control. see **V-TAIL (ACRO/GLID)**. see p. 45.

Note: Only one of the three tail-type functions (**AILEVATOR**, **V-TAIL**, and **ELEVON**) can be used at a time. The radio provides a warning and will not allow the activation of another tail type until the first is deactivated. An error message of **OTHER WING MIXING IS ON** will display. (See the wing type example on page 38.)

Using ELEVON(ACRO/GLID 1A+1F): used with delta wings, flying wings, and other tailless aircraft that combine aileron and elevator functions, using two servos, one on each elevon. The aileron/elevator responses of each servo can be adjusted independently. This is also popular for ground model use, such as tanks, which drive two motors together for forward, and one motor forward/one backward for turning.

```
[ELEVON]
MIX▶INH
      (L) (R)
RATE-AIL1▶+100% +100%
      AIL2▶+100% +100%

      ELE2▶+100%
      ELE1▶-100%
```

(ACRO)

```
[ELEVON]
MIX▶INH
      (L) (R)
RATE-AIL1▶+100% +100%
      AIL2▶+100% +100%

      ELE2▶+100%
      ELE1▶-100%
```

(GLID 1A+1F)

Adjustability:

- Requires use of CH1 and CH2.
- Independently adjustable aileron travel allows aileron differential.
- Independently adjustable elevator travel allows for differences in up vs. down travel.
- The separate **ELEVON** settings for each condition can be set. (**GLID** only)

[Note] When changing the polarity of a rate, "change rate dir?" is displayed for a check. Please set up after pressing **DIAL** for 1 second and canceling an alarm display. (**GLID** only)

NOTE: If **ELEVON** is active, you cannot activate **FLAPERON**, **AILE-DIFF**, or **AILEVATOR**. An error message **OTHER WING MIXING IS ON** displays and you must deactivate the last function to activate **ELEVON**.

NOTE: Be sure to move the elevator and aileron sticks to full deflection during setup. If large travels are specified, when the AILERON and ELEVATOR STICKS are moved at the same time the controls may bind or run out of travel.

(For details on setting up a complex aerobatic plane, please contact www.radiolink.com.cn. Many other setup examples are also available at this location.)

GOAL of EXAMPLE:	STEPS:	INPUTS:
Activate ELEVON . Adjust aileron down travel to 90% of up travel, creating aileron differential.	Open the ELEVON function.	(MODE) for 1 second. (If BASIC , (MODE) again.) Ⓒ to ELEVON . Ⓒ
	Activate the function.	Ⓒ to MIX . Ⓒ to ACT .
	<i>Optional: adjust the up/down travel separately for the servos as ailerons. (Ex: down to 90%.)</i>	Ⓒ to AIL1 . Ⓒ AILERON STICK . Ⓒ to 90% . Ⓒ to AIL2 . Ⓒ AILERON STICK . Ⓒ to 90% .
	<i>Optional: adjust the elevator travel of each servo. (Ex: right servo elev. travel to 98%, left to 105%.)</i>	Ⓒ to ELE2 . Ⓒ to 98% . Ⓒ to ELE1 . Ⓒ to 105% .
	Close menu.	(END) (END)
<i>Where next?</i>	Adjust individual servo's SUB-TRIMS : see p. 36 and END POINTS : see p. 27. Set up dual/triple rates and exponential(D/R,EXP): see p. 30. View more on the internet: www.radiolink.com.cn/doce/	

Dual Elevator Servos (with a rudder) (AILEVATOR) (ACRO): Many models use two elevator servos, plugged in separate receiver channels. (Flying wings without a separate aileron control use **ELEVON**. V-shaped tail models use **V-TAIL**, p. 45.

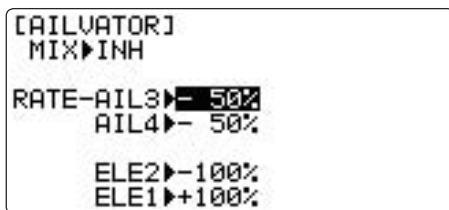

Benefits:

- Ability to adjust each servo's center and end points for perfectly matched travel.
- Ease of assembly, not requiring torque rods for a single servo to drive 2 surfaces.
- Elevators acting also as ailerons for extreme stunt flying or more realistic jet flying (optional).
- Redundancy, for example in case of a servo failure or mid-air collision.

Adjustability:

- CH2 and CH8 only. (With programmable mixing, could utilize CH5 as the 2nd elevator servo. **THROTTLE-NEEDLE** uses CH8 and cannot be active simultaneously.
- Direction of each servo's travel may be reversed in **REVERSE** or the set percentages may be reversed here.
- Elevator travels independently adjustable (both directions and percent).
- Optional action as ailerons (defaults to **50%** response). This response cannot be activated/deactivated in flight. Setting **AIL1** and **2** to **0** disables this feature. Note: if you want this, but on/off with a switch, set **AIL1** and **2** to **0** here, and use 2 mixes. **AIL-to-ELEV** and **AIL-to-AUX2** (link/trim off, assign a switch). to get aileron action from the elevator servos when the assigned switch is on. See p. 68.

(For details on setting up a complex aerobatic plane, such as one with 4 wing servos, full span ailerons/flaps, AIRBRAKE/crow etc, please contact us: www.radiolnk.com.cn. Many other setups are also available.)

The **AILEVATOR** mixing function uses one servo on each of the two elevators, and combines the elevator function with the aileron function (unless aileron travel is set to **0**). For aileron effect, the elevators are raised and lowered opposite of one another in conjunction with the ailerons.

Once **AILEVATOR** is activated, unless you zero out the aileron figures (see below), any time you move your ailerons or any programming moves your ailerons (ie. **RUDDER-AILERON** mixing), the radio automatically commands both elevator servos to also operate as ailerons. To deactivate this action, simply set the 2 aileron travel settings to **0** in the **AILEVATOR** function. This way the elevators will work only as elevators.

If using the elevators as ailerons as well, be sure to move the elevator/aileron stick while checking the servo motions. If a large travel is specified, when the sticks are moved at the same time, controls may bind or run out of travel.)

GOAL of EXAMPLE:	STEPS:	INPUTS:
Activate twin elevator servos. Deactivate the elevator-acting-as-aileron portion of this function. Note: Depending upon your model's geometry, you may need to reverse one servo or set a negative percentage here.	Open the AILEVATOR function.	(MODE) for 1 second. (If BASIC , (MODE) again.) ⬇️ to AILEVATOR . ⚙️
	Activate the function.	⬇️ to MIX . ⚙️ to ACT .
	<i>Optional: adjust up/down travel when operating as ailerons. (Ex: 0.)</i>	⬇️ to AIL3 . ⚙️ to 0% . ⬇️ to AIL4 . ⚙️ to 0% .
	<i>Optional: adjust total elevator travel of each servo. (Ex: right servo elevator travel to 98%, left to 96%.)</i>	⬇️ to ELE2 . ⚙️ to 98% . ⬇️ to ELE1 . ⚙️ to 96% .
	Close menu.	(END) (END)
<i>Where next?</i>	Adjust individual servo's SUB-TRIMS : see p. 36 and END POINTS : see p. 27. Set up Twin Aileron Servos: see p. 39. Set up AIRBRAKE mix: see p. 48.	

Using **V-TAIL (ACRO/GLID)**:

```
[V-TAIL]
MIX▶INH
RATE-ELE1▶+ 50%
ELE2▶- 50%

RUD2▶+ 50%
RUD1▶+ 50%
```

V-TAIL mixing is used with v-tail aircraft so that both elevator and rudder functions are combined for the two tail surfaces. Both elevator and rudder travel can be adjusted independently on each surface.

NOTE: If **V-TAIL** is active, you cannot activate **ELEVON** or **AILEVATOR** functions. If one of these functions is active, an error message will be displayed and you must deactivate the last function prior to activating **ELEVON**. see the wing example on page 43.

NOTE: Be sure to move the elevator and rudder sticks regularly while checking the servo motions. If a large value of travel is specified, when the sticks are moved at the same time, the controls may bind or run out of travel. Decrease the travel until no binding occurs.

Adjustability:

- Requires use of CH2 and CH4.
- Independently adjustable travels allow for differences in servo travels.
- Rudder differential is not available. (To create rudder differential, set **RUD1** and **2** to **0**, then use two programmable mixes, **RUD-ELE** and **RUD-RUD**, setting different percents for up and down. These are your new rudder travels. Trim and link off, switch assignment null so you can't accidentally turn off rudder. see **PROG.MIX**, p. 47.)

(For details on setting up a complex plane, such as one with a v-tail AND a separate steerable nosewheel, please contact us at www.radiolink.com.cn. Many other setup examples are also available at this location.)

GOAL of EXAMPLE:	STEPS:	INPUTS:
Activate V-TAIL .	Open the V-TAIL function.	(MODE) for 1 second. (If BASIC , (MODE) again.) ⊕ to V-TAIL . ☀
Adjust left elevator servo to 95% travel to match to right servo's travel.	Activate the function.	⊕ to MIX . ☀ to ACT .
	<i>optional: adjust the travels separately for the 2 servos as elevators. (Ex: set left to 95%.)</i>	⊕ to ELE1 . to 95% . Repeat as necessary for other servos.
	Close menu.	(END) (END)
<i>Where next?</i>	Adjust END POINTS : see p. 27 and SUB-TRIMS : see p. 36. Set up dual/triple rates and exponential(D/R,EXP): see p. 30. Set up ELEV-FLAP mix: see p. 48. View more on the internet: www.radiolink.com.cn/doce/	

Snap Rolls at the flick of a switch (SNAP-ROLL) (ACRO):

```
[SNAP-ROLL] (1:R/U)
-rate- MIX▶INH
AILE▶+100% SAFE-MODE▶FREE
ELEV▶+100% DIR-SW1▶NULL
RUDD▶+100% 2▶NULL
```

This function allows you to execute snap rolls by flipping a switch, providing the same input every time. It also removes the need to change dual rates on the 3 channels prior to performing a snap, as **SNAP-ROLL** always takes the servos to the same position, regardless of dual rates, inputs held during the snap, etc.

Note: Every aircraft snaps differently due to its C.G., control throws, moments, etc. Some models snap without aileron; others snap on elevator alone. Most models snap most precisely with a combination of all 3 surfaces. Additionally, rate of speed and acceleration when using the snap switch will affect how the model snaps. For information on using gyros with airplanes for cleaner precision maneuvers, such as snaps and spins without over rotation, see p. 56.

Adjustability:

- *Travel:* Adjust the amount of elevator, aileron and rudder travel automatically applied.
- *Range:* -120 to +120 on all 3 channels. Default is **100%** of range of all 3 channels.
- *Directions:* Up to 4 separate snaps may be set up, one for each of the 4 direction choices (up/right, down/right, up/left, down/left). Each snap is fully adjustable regarding travels and direction on each of the 3 channels.
Note: for simplicity, the radio refers to snaps that use “UP” or positive elevator as “U” or “UP” snaps. This is more commonly referred to as a positive or inside snap. “D” or “DOWN” snaps are more commonly referred to as negative or outside snaps.
- **R/U** = Right positive **R/D** = Right negative **L/U** = Left positive **L/D** = Left negative snap roll
- Assignment of the 2 switches (**DIR-SW1/2**) to change snap directions is fully adjustable and optional. If you wish to have only one snap, leave the switches as **NULL**. (If assigned, **SW1** = up/down, **SW2** = left/right.)
- Caution: it is critical that you remember if you assigned switches to select the three additional snaps.
 - For example, assign **SWITCH A** for U/D snap direction, and then also assign **SWITCH A** for elevator dual rates. While flying on elevator low rate (**SWITCH A DOWN**) you pull your snap **SWITCH**. The model will:
 - use the throws set in the snap programming (the low rate elevator has no effect); and
 - be a down (negative/outside) snap, not an up (positive/inside) snap.
 - Both of these may come as a great surprise and risk crashing if you are unprepared.
- Safety Switch (**SAFE-MOD**): a safety may be set up on your landing gear **SWITCH**, preventing accidental snap rolls while the landing gear is down. The safety switch is turned on and off with the landing gear **SWITCH**.
 - **ON:** the safety mechanism is activated when the landing gear SWITCH is in the same position as at the time this feature is changed to **ON**. Snap rolls will not be commanded even if the snap roll **SWITCH** is turned on with the gear **SWITCH** in this position. When the landing gear **SWITCH** is moved to the opposite position, snap rolls may be commanded.
 - **OFF:** activates the safety mechanism in the opposite position from the **ON** function.
 - **FREE:** the safety mechanism is completely turned off. Snaps can be commanded regardless of the gear **SWITCH POSITION**.**Note:** The location of the safety switch always follows channel 5. If channel 5 is reassigned to switch C, for example, switch C is now the safety. If channel 5 is nulled or used as the second aileron servo, the safety function will not be available.
- Trainer Safety: **SNAP-ROLL** is automatically disabled when the trainer function is activated.

GOAL of EXAMPLE:	STEPS:	INPUTS:
Activate SNAP-ROLL . Adjust elevator travel to 55% , rudder travel to 120% in the right/up snap. Activate SAFE-MOD so snaps can not be performed when gear is down. Adjust rudder travel in the left/down snap to 105% . <i>(Note: using negative percents can change any of the 4 snap directions. For example, change snap 1 to "down" by changing the elevator percent to -100%.)</i>	Open the SNAP-ROLL function.	(MODE) for 1 second. (If BASIC , (MODE) again.) ⌚ to SNAP-ROLL . ⌚
	Activate the function.	⌚ to MIX . ⌚ to OFF or ON .
	Adjust the travels as needed. (Ex: elevator to 55% , rudder to 120% .)	⌚ to ELEV . ⌚ to 55% . ⌚ to RUDD . ⌚ to 120% .
	<i>Optional: Activate SAFE-MOD. [Ex: ON when SWITCH E (AT10) or G (AT10) is down, meaning snap function is deactivated when that switch is in the down position.]</i>	⬆ E or G up. ⌚ to SAFE-MODE ⌚ to ON . ⬆ snap switch. Notice MIX reading is still OFF . ⬆ E or G down. Notice MIX reading changes to ON .
	<i>Optional: Assign switches to up/down and left/right. (Ex: Change to the left/down snap and adjust rudder to 105%.)</i>	⌚ to SW1 . ⌚ to A. ⌚ to SW2 . ⌚ to B. ⬆ A down B down. Repeat steps above to set percentages.
Close menu.	(END) (END)	
Where next?	Set up programmable mixes: see p. 47. View more on the internet: www.radiolink.com.cn./doce/	

MIXES: *the backbone of nearly every function*

Mixes are special programs within the radio that command one or more channels to act together with input from only one source, such as a stick, slider or knob.

There are a variety of types of mixes.

Types:

- **Linear:** Most mixes are linear. A 100% linear mix tells the slave servo to do exactly what the master servo is doing, using 100% of the slave channel's range to do so. An example is **FLAPERON**, when aileron stick is moved, the flap servo is told to move exactly the same amount. A 50% linear mix would tell the slave servo, for example, to move to 50% of its range when the master's control is moved 100%. (see p. 39.)
- **Offset:** An **OFFSET** mix is a special type of linear mix. When the mix is turned on (usually a flip of a switch), the slave servo is moved a set percent of its range. An example of this is **AIRBRAKE**, moving flaps, flaperons, and elevator all to a set position at the flip of a switch. (see p. 49.)
- **Curve:** Curve mixes are mostly used in helicopters, but may also be used in airplanes and gliders. An example is **THROTTLE-NEEDLE** mixing, where the in-flight needle's servo is moved, changing the mixture, as the throttle servo is moved. (see p. 50.)
- **Delay:** Delay mixes are part of a few very special functions that make the servo move to its desired range more slowly. **THROTTLE DELAY** (simulates turbine engines, p. 51) and the elevator delay in **AIRBRAKE** are two examples of this (see p. 48). **DELAY** in **HELI** (see p. 82) is another example that slows the servo movement to the trim settings for the other conditions.

Essentially every feature in the radio's programming is really a mix, with all assignments/programming set up and ready to use. Additionally, the AT10 **ACRO** and **GLID** programs both provide 4 linear and 4 curve fully-programmable mixes (**HELI** provides 4 linear and 2 curve) that allow you to set up special mixes to resolve flight difficulties, activate additional functions, etc.

Let's look quickly at a few examples that are features we've already covered. This may help to clarify the mix types and the importance of mixes.

Additional examples:

- Exponential is a preprogrammed curve mix that makes the servos' response more (+) or less (-) sensitive around center stick (works in conjunction with dual rate, a linear mix that adjusts the total range). see **D/R,EXP**, p. 30.
- **IDLE-DOWN** and **THR-CUT** are two **OFFSET** pre-programmed mixes. These tell the throttle servo, when below a certain point, to move toward idle an additional set percentage to help close the carburetor. see p. 28.
- **ELEV-TO-FLAP** mixing is a pre-programmed linear mix to move the flaps proportionally to elevator control, helping the model loop even tighter than it can on elevator alone. (see p. 48.)
- **THROTTLE-NEEDLE** mixing is a curve mix (like **PROG.MIX 5 to 8**) for proper in-flight needle setup. (see p. 50.)
- **THROTTLE DELAY** mixing is a pre-programmed delay mix that slows down the response of the CH3 servo. (see p. 51.)

Next, we'll get an in-depth look at some pre-programmed mixes (*mixes whose channels are predefined for simplicity*) we've not covered yet, and last, look at the fully-programmable mix types.

ELEV-FLAP mixing (ACRO/GLID):

```
[ELEV→FLAP]
MIX▶INH
RATE↑▶+ 50%
      ↓▶+ 50%
SW▶SwC
POSI▶UP
```

(ACRO)

```
[ELEV→FLAP]           MIX▶INH
FLP1/2↑▶+ 10%        NORML←
                   ↓▶+ 10%        START
AIL1/2↑▶+ 10%        SPEED
                   ↓▶+ 10%        DISTA
RANGE▶ 0% (< 0%)    LANDI
SW▶SwC  POSI▶UP
```

(GLID)

ELEV-FLAP mixing is the first pre-programmed mix we'll cover. This mix makes the flaps drop or rise whenever the *ELEVATOR STICK* is moved. It is most commonly used to make tighter pylon turns or squarer corners in maneuvers. In most cases, the flaps droop (are lowered) when up elevator is commanded.

Adjustability:

- **Rate:** -100% (full up flap) to +100 (full down flap), with a default of +50% (one-half of the flap range is achieved when the *ELEVATOR STICK* is pulled to provide full up elevator.)
- **Switch:** fully assignable. Also **LOGIC SW (Lsw1 to 3)** may be assigned. Set up **LOGIC SW:** See p. 26.
*IF you set it to **NULL**, the mix does not work. (ACRO)
- **Range (GLID):** The range that mixing does not work near neutral of an elevator stick can be set up.
Hold the stick to the desired point (upper or lower side), then press **DIAL** and hold one second to set the range.
- **Condition (GLID):** The separate **ELEV-FLAP** settings for each condition can be set.

GOAL of EXAMPLE:	STEPS:	INPUTS:
Activate ELEV-FLAP mixing. Adjust flap travel to 0% flaps with negative elevator (push) and 45% flaps with positive elevator.	Open the ELEV-FLAP function.	(MODE) for 1 second. (If BASIC , (MODE) again.) ⊙ to ELEV-FLAP . ☀
	Activate the function.	⊙ to MIX . ⚙ to ACT .
	Adjust the travels as needed. (Ex: 0% , to 45% .)	⊙ to RATE . ⬆ ELEVATOR STICK . ⚙ to 0% . ⬆ ELEVATOR STICK . ⚙ to 45% .
	Close menu.	(END) (END)
<i>Where next?</i>	Adjust flaperons' flap travel available (FLAPERON): see p. 39. Set up AIRBRAKE (crow/butterfly): see p.48. Set up programmable mixes (ex: FLAP-ELEVATOR): see p. 53. View more on the internet: www.radiolink.com.cn/doce/	

AIRBRAKE/BUTTERFLY (crow) mixing (ACRO/GLID):

```
[AIR-BRAKE]
-rate-
AIL1▶ ---        MIX▶INH
ELEV▶- 10%      SW▶SwC
FLAP▶+ 50%      ▶DOWN
AIL2▶ ---        MODE▶Offset
-delay-
ELEV▶ 0%
```

(ACRO)

```
[BUTTERFLY]
-rate-
AIL1▶ 0%        CIR▶1 (-)
FLAP▶ 0%        MIX▶INH
AIL2▶ 0%        SW▶SwA
SPOI▶ ---       ▶DOWN
PRESET▶ 15% (< 50)
```

(GLID)

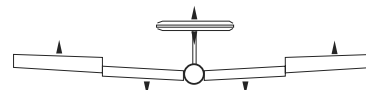

Like **FLAPERON** and **AILEVATOR**, **AIRBRAKE** is one function that is really made up of a series of pre-programmed mixes all done for you within the radio. **AIRBRAKE**(often called "crow" or **BUTTERFLY** - see **GLID**, p. 62 for details) simultaneously moves the flap(s) (if installed), twin ailerons (if installed) and elevator(s), and is usually used to make steep descents or to limit increases in airspeed in dives.

This function is often used even on models without flaps as an easy way to use the flaperons and **FLAP-ELEVATOR** mixing together.

Adjustability:

- **Activation:** Proportional by moving the **THROTTLE STICK**, or set positions by flipping the assigned switch.
- **Switch:** Mix **SWITCH** is selectable.
 - *Also **LOGIC SW** (*Lsw1 to 3*) may be assigned. Set up **LOGIC SW**: See p. 26.
- **Linear** (*Inversely proportional to THROTTLE STICK*): provides a proportional increase in amount of **AIRBRAKE** action as **THROTTLE STICK** is lowered and assigned switch is on. Provides gradually more **AIRBRAKE** as you slow the engine. Includes selectable stick position where **AIRBRAKE** begins, gradually increasing to the same setting as the **THROTTLE STICK** is lowered. If you would like to have the airbrake be directly proportional to throttle stick, you will need to reverse the **THR-REV** function. Note that this changes the throttle stick direction for all models. See page 38 for instructions.
- **Offset:** Provides **AIRBRAKE** response immediately upon switch movement, going to a pre-set travel on each active channel without any means of in-flight adjustment.
- During Airbrake operation, the elevator travel is displayed on the elevator trim display in the Startup screen.
- **Delayed reaction:** You can suppress sudden changes in your model's attitude when **AIRBRAKE/BUTTERFLY** is activated by setting the delay (**delay-ELEV**) item, to slow down the elevator response, allowing the flaps/ailerons/elevator to all reach their desired end point together. A setting of **100%** slows the servo to take approximately one second to travel the prescribed distance. (**GLID: B.FLY-ELEV** function)
- **Adjustable in flight (ACRO):** Using the aileron (when **AILE-DIFF** or **FLAPERON** is activated) and elevator trim lever in flight can be set to adjust the aileron and elevator settings in your airbrake rather than adjusting the model's actual aileron and elevator trim. This allows easy adjustment for any ballooning while in flight. When the airbrake switch is moved to off the trims are again adjusting the normal elevator trim.
- **Channels controlled:** Elevator(s), twin ailerons and flap(s) may be set independently in **AIRBRAKE**, including set to 0 to have no effect.
 - Twin aileron servos: If **FLAPERON**, **ELEVON** and **AILE-DIFF** functions are inhibited, then **AIL1** and **AIL2** settings will have no effect.
 - If **FLAPERON** is active, the travel of the ailerons can be independently adjusted for the servos plugged into CH1 and CH6. The flap choice has no effect on the flaperons.
 - If **AILE-DIFF** is active, then CH1 and CH7 may be independently adjusted.
 - Normally both ailerons are raised equally in **AIRBRAKE**, and the elevator motion is set to maintain trim when the ailerons rise. Different amounts may be set for each aileron to correct for torque reactions and other unique characteristics of the model.

⚠ Be sure you understand what dropping ailerons will do when in **AIRBRAKE/BUTTERFLY**. Along with creating an enormous amount of drag (desireble for spot landings), this also creates "wash-in", a higher angle of attack where the ailerons are, and encourages tip stalling. If you are using this for aerobatic performance and not "sudden stops", consider raising the ailerons and dropping the flaps instead as shown in the diagram above.

- **Twin elevator servos:**
 - If **AILEVATOR** is active, the **AIL1** and **AIL2** settings still only affect **FLAPERON** or **AILE-DIFF** servos, NOT the elevator servos. (they would have the **AIL3** and **AIL4** settings.)

GOAL of EXAMPLE:	STEPS:	INPUTS:
Activate AIRBRAKE on a FLAPERON model. Adjust the flaperon travel to 75% , with negative elevator (push) of 25% .	Confirm FLAPERON is active.	see FLAPERON instructions.
	Open the AIRBRAKE function.	(MODE) for 1 second. (If BASIC , (MODE) again.) ⊙ to AIRBRAKE . ☀
	Activate the function.	⤴ Switch C in up position. ⊙ to MIX . ☀ to OFF .
	Adjust the travels as needed. (Ex: Ailerons each 75% , Elevator -25% .)	⊙ to AIL1 . ☀ to 75% . ⊙ to ELEV . ☀ to -25% . ⊙ to AIL2 . ☀ to 75% .
	Optional: delay how quickly the elevator servo responds.	⊙ to delay- ELEV . ☀ to 25% .
	Optional: change the mixing from full amount upon switch to proportional to the THROTTLE STICK 's proximity to idle.	⊙ to MODE . ☀ to Linear (0%) . ⊙ THROTTLE STICK to desired 0 point. <small>(display changes if new setting is different from prior setting).</small>
	Close menu.	(END) (END)
Where next?	Adjust flaperons' total flap travel available (FLAPERON): see p. 39. Set up ELEV-FLAP mixing: see p. 48. Set up programmable mixes, for example, FLAP-ELEVATOR : see p. 57. View more on the internet: www.radiolink.com.cn/doce/	

THROTTLE-NEEDLE mixing (ACRO/HELI):

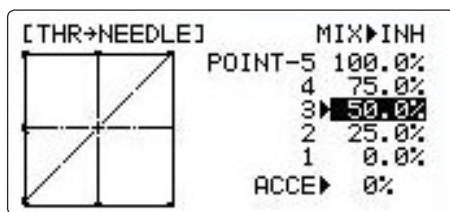

(ACRO)

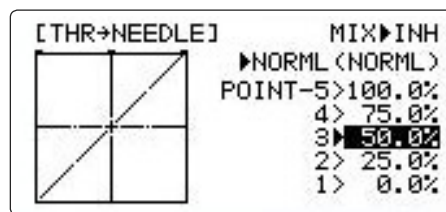

(HELI)

THROTTLE-NEEDLE is a pre-programmed mix that automatically moves an in-flight mixture servo (CH8) in response to the **THROTTLE STICK** inputs for perfect engine tuning at all throttle settings. This function is particularly popular with contest pilots who fly in a large variety of locations, needing regular engine tuning adjustments, and requiring perfect engine response at all times and in all maneuvers. Also popular to minimize flooding at idle of inverted engine installations or installations with a high tank position. Not needed for fuel injection engines, which do this automatically.

Adjustability:

- Five-point curve allows adjustment of engine mixture at varied throttle settings.
- The in-flight mixture servo must connect to receiver CH8.
- In-flight mixture servo may also be used as a second servo for tuning a twin.
- Throttle cut feature also moves the in flight needle servo.

- The CH8 knob adjusts the high throttle mixture (may be deactivated. see **AUX-CH**).
- Because both use CH8, this function cannot be used simultaneously with **AILEVATOR**.
- An acceleration (**ACCE**) function (**ACRO** only) helps the engine compensate for sudden, large amounts of throttle input by making the mixture suddenly richer, then easing it back to the proper adjustment for that throttle setting. This function requires some adjustment to best fit your engine and your flying style. Adjust engine's response until no hesitation occurs on rapid throttle input.
- Separate curves are available (**HELI** only) for normal, idle-ups 1 and 2 combined, and idle-up 3. Immediately below **MIX** the radio displays the curve you are editing; ex: **>NORML**; and then which condition is currently active by your switches ex: **(ID1/2)**. Note that you can edit the mix for a different condition without being in that condition, to allow editing without having to shut off the helicopter's engine every time. Be sure you are editing the proper curve by checking the name after the **>** and not the one in parentheses.

GOAL of EXAMPLE:	STEPS:	INPUTS:
Activate THROTTLE-NEEDLE mixing. Adjust the points as follows to resolve a slight lean midrange problem: 1: 40% 2: 45% 3: 65% 4: 55% 5: 40%	Open the THROTTLE-NEEDLE function.	for 1 second. (If BASIC , again.) to THROTTLE-NEEDLE .
	Activate the function.	to MIX . to ACT .
	HELI only. Select the condition to edit.	to MIX . to ACT . as needed.
	Adjust the travels as needed to match your engine by slowly moving the stick to each of the 5 points, then adjusting the percentage at that point until the engine is properly tuned.	to POINT- . THROTTLE STICK to POINT1 . to 40% . until POINT 2 is highlighted. to 45% . to POINT 3 . to 65% . to POINT 4 . to 55% . to POINT 5 . to 40%
	ACRO only. <i>Optional: increase mixture when throttle is applied rapidly-ACCE.</i> (see above for details.)	to ACCE . THROTTLE STICK to idle. THROTTLE STICK full open quickly. as needed.
	HELI only: set curves for other conditions.	to condition name. to next condition to edit. Repeat above steps as needed.
	Close menu.	

Throttle delay function THR-DELAY (ACRO):

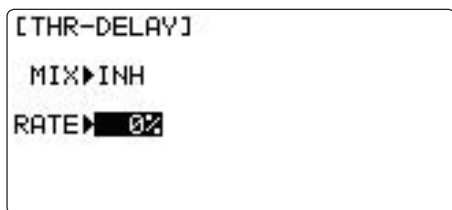

The **THR-DELAY** function is used to slow the response of the throttle servo to simulate the slow response of a turbine engine. A **40%** delay setting corresponds to about a one-second delay, while a **100%** delay takes about eight seconds to respond. For helicopters, see **DELAYS**, p. 82.

This function may also be used to create a “slowed servo” on a channel other than throttle. This is accomplished by plugging the desired servo (Ex: gear doors) into CH3 (**THR**), throttle into an auxiliary channel such as 8, and then using some creative mixes. Please contact us at www.radiolink.com.cn/doce/ for this specific example.

GOAL of EXAMPLE:	STEPS:	INPUTS:
Activate THR-DELAY for a ducted-fan replica of a turbine-powered aircraft. Slow the servo response by one second.	Open the THR-DELAY function.	MODE for 1 second. (If BASIC , MODE again.) ☺ to THR-DELAY . ☺
	Activate the function.	☺ to MIX . ☺ to ACT .
	Adjust the RATE to match the desired servo speed. (Ex: 40% .)	☺ to RATE . ☺ to 40% .
	Close menu.	END END
Where next?	Set up THROTTLE-NEEDLE mixing: see p. 50. Adjust throttle's END POINT : see p. 27. Adjust throttle exponential (D/R,EXP): see p. 30. Set up AILEVATOR : see p. 44. Set up programmable mixes, for example, RUDDER-AILERON : see p. 55. View more on the internet: www.radiolink.com.cn/doce	

Throttle curve (**THR-CURVE**)(**ACRO**):

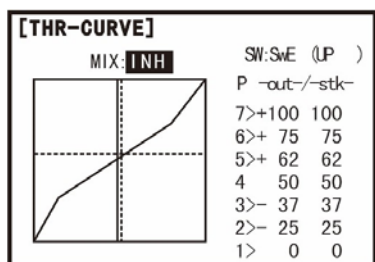

This function adjust the throttle operation curve for optimum the engine speed to throttle stick movement.

NOTE: If the throttle **EXP** function is activated, you can not use **THR-CURVE** function simultaneously.

Adjustability:

- Separate curves for each switch position are available.
- *Moving and deleting the curve point:* The curve point (**-stk-**) can be moved to the left or right by turning the **DIAL** (up to 2% in front of the adjoining point) and deleted/returned by pressing the **DIAL** for one second alternately.

GOAL of EXAMPLE:	STEPS:	INPUTS:
<i>Base point:</i> Adjust base point of throttle curve until engine idles reliably. -out- : output, servo position. -stk- : curve point, stick position.	Open the THR-CURVE function.	MODE for 1 second. (If BASIC , MODE again.) ☺ to THR-CURVE . ☺
	Activate the function.	☺ to MIX . ☺ to ON .
	Adjust the first point.	☺ to point 1 (-out-). ☺ to desired throttle servo position.
	<i>Optional: Assign the switch.</i>	☺ to SW . ☺ to desired switch.
	<i>Optional: Move the curve point. (Ex: point 3)</i>	☺ to point 3 (-stk-). ☺ to desired curve point to move to left or right.
<i>Next point:</i>	<i>Optional: Delete the curve point. And return the curve point. (Ex: point 3)</i>	☺ to point 3 (-stk-). ☺ for one second to delete the curve point. ☺ to point 3 (-stk-). ☺ for one second to return.
	Adjust the next point.	Repeat as needed.
	Close.	END END

LINEAR PROGRAMMABLE MIXES (PROG.MIX1-4):

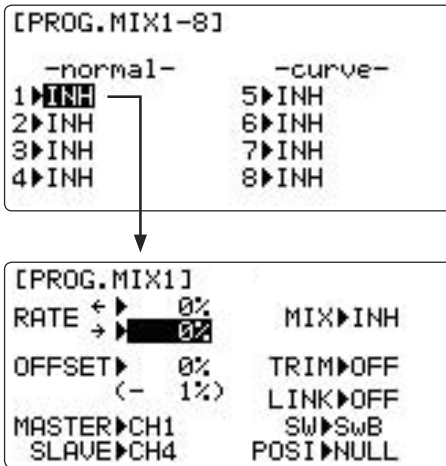

Your AT10 contains four separate linear programmable mixes. (Note that mixer #5-8's mixing **RATES** are set with a 5-point curve. **HELI** has mixer #5-6's mixing. see CURVE MIXES, p. 55.)

There are a variety of reasons you might want to use these mixes. A few are listed here. All of the adjustable parameters are listed below, but don't let them scare you. For your first few times experimenting with mixes, just turn on the default mixes, adjust them how you think they need to be, then use the servo screen to check and see if you were correct. As with all functions, a sample setup follows, step by step, to assist you.

Sample reasons to use linear programmable mixes:

- To correct bad tendencies of the aircraft (such as rolling in response to rudder input).
- To operate 2 or more servos for a single axis (such as two rudder servos).
- To automatically correct for a particular action (such as lowering elevator when flaps are lowered).
- To operate a second channel in response to movement in a first channel (such as increasing the amount of smoke oil in response to more throttle application, but only when the smoke switch is active).
- To turn off response of a primary control in certain circumstances (such as simulating one engine flaming-out on a twin, or throttle-assisted rudder turns, also with a twin).

Adjustability:

- **Defaults:** The 4 programmable mixes default to the most frequently used mixes for simplicity. If you want to use one of these mixes, simply select that mix number so that the master and slave servos are already selected for you.
 - **PROG.MIX1** aileron-to-rudder for coordinated turns
 - **PROG.MIX2** elevator-to-flap for tighter loops (**HELI** mixes default to elev-to-pitch.)
 - **PROG.MIX3** flap-to-elevator to compensate pitching with flaps (**HELI** mixes default to pitch-to-elev.)
 - **PROG.MIX4** throttle-to-rudder ground handling compensation
- **Channels available to mix:** All four mixes may use any combination of CH1-8. (CH9-10 are not proportional and cannot be mixed.) Offset and dials may also be set to the master channels. (see below.)
- **Master:** the controlling channel. The channel whose movement is followed by the slave channel.
 - **Another channel:** Most mixes follow a control channel. (Ex: rudder-to-ailerons, 25%, no switch, corrects roll coupling.)

MASTER	SLAVE	LINK	TRIM	SWITCH	POSITION	RATE	OFFSET
RUDD	AILE	ON	OFF	ANY	NULL	25%	0

- **Offset as master:** To create an **OFFSET** mix, set the master as OFST. (Ex: move flaperons as flaps 20% of their total throw when **SWITCH C** is in down position.)

MASTER	SLAVE	LINK	TRIM	SWITCH	POSITION	RATE	OFFSET
OFST	FLAP	ON	N/A	C	DOWN	20%	0

- **Dial as master:** To directly effect one servo's position by moving a dial, set the master as the desired dial. (Ex: create a second throttle trim on left slider.)

MASTER	SLAVE	LINK	TRIM	SWITCH	POSITION	RATE	OFFSET
VR(D)	THRO	OFF	N/A	ANY	NULL	5%	0

- **Slave:** the controlled channel. The channel that is moved automatically in response to the movement of the master channel. The second channel in a mix's name (i.e. aileron-to-rudder).
- **Link:** link this programmable mix with other mixes.
Ex: PMIX **FLAP-ELEVATOR** mixing to correct for ballooning when flaps are lowered, but model has a V-tail. Without **LINK**,

this mix only moves CH2 elevator when flap is commanded, resulting in a dangerous combination of yaw and roll. With **LINK ON**, mixing is applied to both CH2 and CH4.

MASTER	SLAVE	LINK	TRIM	SWITCH	POSITION	RATE	OFFSET
FLAP	ELEV	ON	OFF	ANY	NULL	5%	0

• *Trim:* master's trim affects slave. Not displayed if master is not CH 1-4, because 5-9 have no trim. Ex: two rudder servos. With **TRIM OFF**, rudder trim would bind the two servos. **TRIM ON** resolves this.

• *On/off choices:*

- **SWITCH:** Any of the positions of any of the 8 switches may be used to activate a mix. **Up&Cntr**, **Cntr&Dn** options allow the mix to be **ON** in 2 of the 3 positions of a 3-position **SWITCH**.
- **NULL:** No **SWITCH** can turn this mix **OFF**. This mix is active at all times.
- **LOGIC SW (Lsw1 to 3)** may be assigned. Set up **LOGIC SW:** See p. 26.
- **STk-THR:** Turned on/off by **THROTTLE STICK** movement. Trigger point/direction are selectable. Ex: **OFST**-to-(gear doors) mix to open gear doors at idle, which is only active if throttle is below half.

MASTER	SLAVE	LINK	TRIM	SWITCH	POSITION	RATE	OFFSET
OFST	AUX2	OFF	NO	STK-THR	Stick at 1/2, for 1 sec.	100%	0

• *Rate:* the percentage of the slave's range it will move upon maximum input from the master channel. Ex: **RUDDER-AILERON** mix, 50%. Ail range=1". When rudder is moved full right, ailerons move 1/2".

MASTER	SLAVE	LINK	TRIM	SWITCH	POSITION	RATE	OFFSET
RUDD	AILE	OFF	OFF	ANY	NULL	50%	0

• *Offset:* Offsets the slave's center relative to the master. Ex: Smoke valve opens wider per throttle servo position when smoke **SWITCH** is **ON**. Smoke servo's neutral is moved down from **THROTTLE STICK** center to the bottom.

MASTER	SLAVE	LINK	TRIM	SWITCH	POSITION	RATE	OFFSET
THRO	AUX2	OFF	OFF	E	DOWN	100%	100%

GOAL of EXAMPLE:	STEPS:	INPUTS:
Set up a FLAP-ELEV mix: ON when SWITCH C is in the down position.	Open an unused programmable mix. (Ex: use PROG.MIX3 since it is already set-up for FLAP-ELEVATOR .)	(MODE) for 1 second. (If BASIC , (MODE) again.) ⊕ to PROG.MIX- . ⊕ ⊕ to 3 > . ⊕
No elevator movement when flaps move up (spoilers),	Activate the function.	⊕ to MIX . ⊕ to ON .
5% elevator movement when flaps move down,	Choose master and slave channels. (Ex: no need to change MASTER/SLAVE .)	already CH6 already CH2
LINK should be ON if model has twin elevator servos. Otherwise, LINK remains OFF .	<i>Optional: set Master as OST or VR(A-E). See above for details.</i>	⊕ to MASTER . ⊕ to desired choice.
(Flap has no trim lever, so TRIM is not an option.)	Set LINK and TRIM as needed. (Ex: leave LINK OFF , TRIM not available.)	
	Assign SWITCH and position. (Ex: change from E to C , DOWN .)	⊕ to SW . ⊕ to C . ⊕ to POSI . ⊕ to DOWN .
	<i>Optional: set switch to STk-THR to activate mix with THROTTLE STICK. (See above for details.)</i>	⊕ to SW . ⊕ to STk-THR . ⊕ to POSI . ⊕ THROTTLE STICK to desired point. ⊕ for 1 second to set.
	<i>Optional: set switch position to NULL. Makes mix active at all times. Not compatible with STk-THR.</i>	⊕ to POSI . ⊕ to NULL .
	Set rates. (Ex: Lo= 0% , Hi= 5% .)	⊕ to RATE . ⊕ VR(A) past center. Leave at 0% . ⊕ VR(A) past center. ⊕ to 5% .

	Set OFFSET , if needed. (Ex: 0 .)	⊕ to OFFSET . Leave at 0% .
	Close menu.	END END
<i>Where next?</i>	Adjust servo END POINTS : see p. 27. Setup dual/triple rates and exponential (D/R,EXP): see p. 30. Set up additional programmable mixes, ex: RUDDER-AILERON : see p. 55. View numerous additional mix setups: www.radiolink.com.cn/doce .	

Other Examples:

- **RUDD-ELEV (ACRO/GLID)** mix: Compensate for pitching up or down when rudder is applied.
- **AIL-RUD** mix (**ACRO**): Coordinate turns by applying rudder automatically with aileron input. All model types.
- **ELEV-PIT (HELI)** mix: compensate for the loss of lift of tilting the model.

CURVE PROGRAMMABLE MIXES (PROG.MIX5-8)(HELI: PROG.MIX5-6):

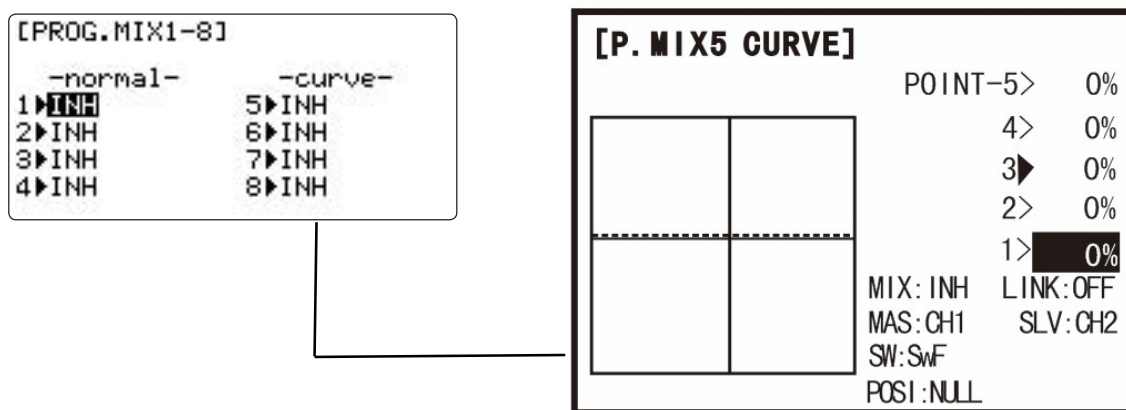

AT10's **ACRO/GLID** programs contain four separate curve programmable mixes. **HELI** contains two. There are a variety of reasons you might want curve mixes . usually where a linear mix doesn't fit your needs along the whole range. One pre-programmed curve mix is the **THROTTLE-NEEDLE** function. This curve is adjustable at 5 points, allowing you to adjust the motor's tuning at 5 points along its RPM range.

One programmable curve mix defaults to **RUDDER-AILERON**. A linear mix that keeps the model from rolling in knife-edge is probably too much aileron when rudder is applied in level flight. Create a curve mix and set all 5 points to match the linear mix. Inhibit the linear mix, then adjust the curve to get the right response all along the rudder channel's travel.

Adjustability: for detailed definitions, see Linear Programmable Mixes and Glossary.

- **ACRO/GLID Defaults:** The 4 programmable curve mixes default to the most frequent choices, but can be set to any channel.
 - **PROG.MIX5** rudder-to-aileron for roll coupling compensation (**GLID** mixes default to aileron-to-elev.)
 - **PROG.MIX6** rudder-to-aileron for roll coupling compensation (**GLID** mixes default to aileron-to-elev.)
 - **PROG.MIX7** rudder-to-elevator for pitch coupling compensation (**GLID** mixes default to elevator-to-airbrake.)
 - **PROG.MIX8** rudder-to-elevator for pitch coupling compensation (**GLID** mixes default to elevator-to-airbrake.)
- **HELI Defaults:**
 - **PROG.MIX5** aileron-to-elevator for coordinated turns
 - **PROG.MIX6** aileron-to-elevator for coordinated turns
- *Master:* The controlling channel can only be a channel. Cannot be **OFFSET** or dial.
- *Trim:* not available in curve mixes.
- *Offset:* not available in curve mixes.

GOAL of EXAMPLE:	STEPS:	INPUTS:
<p>Set up a RUDD-ELEV curve mix on a model that pitches down severely at full rudder and not at all with minimal rudder input, and pitches worse on right rudder than left:</p> <p>Point 1: 25% Point 2: 8% Point 3: 0% Point 4: 10% Point 5: 28%</p> <p>ON when SWITCH C is down.</p> <p>LINK should be ON if model has twin elevator servos. Otherwise, LINK remains OFF.</p> <p>(Note that point 3 is 0%. Otherwise, the elevator would be retrimmed when the mix is active and no rudder input is given.)</p>	Open an unused curve programmable mix. (Ex: use PROG.MIX7 since it is already set-up for RUDDER-ELEV .)	(MODE) for 1 second. (If BASIC , (MODE) again.) to PROG.MIX- . to 7> .
	Activate the function.	to MIX . to ON .
	Choose master and slave channels. (Ex: do not change MAS or SLV .)	already RUDD already ELEV
	Set LINK as needed. (Ex: off)	
	Assign SWITCH and position. (Ex: change from F to C , DOWN .)	to SW . to C . to POSI . to DOWN .
	Optional: set switch to STk-THR to activate mix with THROTTLE STICK . (See above for details.)	to SW . to STk-THR . to POSI . THROTTLE STICK to desired point. for 1 second to set.
	Optional: set switch position to NULL . Makes mix active at all times. Not compatible with STk-THR .	to POSI . to NULL .
	Set desired percent at the stick points. (Ex: listed at left.)	to page 1. to POINT-1 . to 25% . Repeat for points 2-5.
Close menu.	(END) (END)	
Where next?	Adjust servo END POINTS : see p. 39. Set up AILEVATOR : see p. 57. Set up linear programmable mixes, ex: RUDDER-to-Aux2 (twin rudder servos):see p. 53, or additional curve mix, ex: RUDDER-AILERON : see p. 55. View numerous mix setups: www.radiolink.com.cn/doce	

gyro mixing

Gyro operation modes:

The gyros have two operations modes: GY mode and STD mode.

- STD mode: This mode performs general proportional control operation. For instance, it controls the gyro so that changes are countered when the attitude of the aircraft is changed by cross-wind, etc.
- GY mode: This mode performs both proportional and integrated control operation. The difference between Normal mode and GY mode operation is that where as the Normal mode only counters changes in attitude, the GY mode returns to the original controlled variable simultaneously with countering changes in attitude. For example, during knife edge flying, aileron and elevator meeting rudder is normally necessary, but in the GY mode, meeting rudder is performed automatically by the gyro.

[GYRO SENSE]			
MIX-1	▶INH	2▶INH	
UP	▶	▶	0%
CNTR			0%
DOWN	>	>	0%
CH▶CH5		▶CH8	
SW▶G		▶G	

Adjustability:

- Plug the gyro's sensitivity adjustment to channel 5, 7, or 8 of the receiver. (selectable)
- Full switch assignability (**SWITCH A-H**)
- Each rate setting may be set from 0 to NOR100% or AVC100% gain.
NOR: GY mode gain. **AVC**: STD mode gain
- Larger percentages indicate more gain, or gyro responsiveness.
- **MIX-1,2**: Two surfaces' sensitivity can be adjusted independently.

Gyro gain adjustment:

- When the servo hunts, the gyro gain is too high. Lower the gain until the hunting stops.
- The gyro will display best performance at a gain just before hunting occurs. Perform adjusting by flying the aircraft repeatedly.

Precautions:

- When taking off and landing, always switch to the Normal mode. Taking off and landing in the GY mode is dangerous.
- We recommend that you use the rudder control gyro in the Normal mode. In the GY mode, rudder operation is necessary when turning because the weathervane effect is lost. Use the gyro in the Normal mode unless you are an expert in rudder operation.
- And we recommend that you also set to off (0%) mode for safety as follows.

GOAL of EXAMPLE:	STEPS:	INPUTS:
Set up a gyro setting. (Ex: MIX-1)	Open and activate the GYRO SENSE function.	for 1 second. (If BASIC , again.) to GYRO SENSE .
	Activate the function.	to MIX-1 . to ON .
	Optional: change switch assignment. Ex: select E .	to SW to E .
	Adjust gyro rates as needed. (Ex: UP to NOR70% , CNTR to 0% (off) , DOWN to AVC70% as starting points.)	to gyro rate E up. to NOR 70% . 0% . E down. to AVC 70% .
	Close menu.	

GLIDER MODEL FUNCTIONS

Please note that nearly all of the **BASIC** menu functions are the same for airplane (**ACRO** setup), sailplane (**GLID 1A+1F/2A+1F/2A+2F** setups), and helicopter (**HELI** setups). The features that are identical refer back to the **ACRO** chapter. The glider **BASIC** menu includes **MOTOR CUT** and does not include **IDLE-DOWN** or **THR-CUT**.

Note that in all cases where **ACRO** programming labels channel 3 as throttle, **GLID** programming labels channel 3 as **ARB** (airbrake), since airbrakes are normally operated on channel 3 in gliders. This includes **STK-THR** reading **STK-ARB**.



































GLIDER (GLID(1A+1F)/(2A+1F)/(2A+2F)) FUNCTIONS .	58	GLIDER ADVANCE MENU FUNCTIONS	62
Table of contents.....	58	FLAPERON	39
Getting Started with a Basic 4-CH Glider	59	FLAP TRIM	40
GLIDER BASIC MENU FUNCTIONS	61	Aileron Differential (AILE-DIFF).....	41
MOTOR CUT	62	ELEVON (see tail types)	43
MODEL Submenu: MODEL SELECT, COPY, NAME	20	ELEVON	43
PARAMETER Submenu: RESET, MODUL, ATL, AILE-2,		V-TAIL	45
CONTRAST, BACK-LIGHT, USER NAME, LOGIC SW	23	Linear, Prog. mixes 1-4	53
Model type (PARAMETER submenu)	61	Curve, Prog. mixes 5-8	55
Servo REVERSE	26	ELEV-FLAP	48
END POINT	27	BUTTERFLY (modified version of AIRBRAKE).....	48
Dual/Triple Rates and Exponential (D/R, EXP).....	30	BUTTERFLY	48
TIMER Submenu.....	33	AILE/RUDD	63
Auxiliary Channel assignments and CH9 reverse (AUX-		AILE-FLAP (GLID(2A+2F) only)	64
CH).....	34	SPOILER MIX	64
TRAINER	34	OFFSETS (Additional flight conditions)	65
TRIM and SUB-TRIM	35	START DELAY (GLID(1A+1F) only).....	66
SERVO Display	37	CAMBER MIX	67
Fail Safe and Battery FailSafe (F/S).....	37	CAMBER FLAP	67
		Channel 3's function selection (CONDITION/FUNCTION)	69

GETTING STARTED WITH A BASIC 4-CHANNEL (Aileron/Flap/Rudder/Elevator) GLIDER

This guideline is intended to help you get acquainted with the radio, to give you a jump start on using your new radio, and to give you some ideas and direction in how to do even more with this powerful system than you may have already considered. It follows our basic format of all programming pages: a big picture overview of what we're trying to accomplish; a "by name" description of the steps to help acquaint you with the radio; and a step-by-step instruction to leave out the mystery and challenge of setting up your model.

For additional details on utilizing each function, see that function's section in this manual—the page numbers are indicated in the first column as a convenience to you.

GOAL of EXAMPLE:	STEPS:	INPUTS:
Prepare your aircraft.	Install all servos, switches, receiver per your model's instructions. Turn on transmitter then receiver; adjust all linkages so surfaces are nearly centered. Mechanically adjust all linkages to get as close as possible to proper control throws and minimize binding prior to radio set up. Check servo direction and throws. Make notes now of what you will need to change during programming.	
Select the proper MODEL TYPE for your model. (Ex: GLID 1A+1F .) See p. 61 <i>[NOTE: This is one of several functions that requires confirmation to make a change. Only critical changes such as a MODEL RESET require additional key strokes to accept the change.]</i>	In the BASIC menu, open the PARAMETER submenu.	Turn on the transmitter. Ⓜ for 1 second. (If ADVANCE , Ⓜ again.) ⌂ then ⏪ to highlight PARAMETER . ⌂ to choose PARAMETER .
	Go to MODEL TYPE .	⏪ to MODEL TYPE .
	Select proper MODEL TYPE . Ex: GLID(1A+1F) . Confirm the change. Close the PARAMETER submenu.	⌂ to GLID(1A+1F) . ⌂ for 1 second. Are you sure? Displays. ⌂ to confirm. Ⓜ to return to BASIC menu.
NAME the model. P. 32. <i>(Note that you do not need to do anything to "save" or store this data.)</i>	In the BASIC menu, open the MODEL submenu.	⏪ as needed to highlight MODEL . ⌂ to choose MODEL .
	Go to MODEL NAME .	⏪ to NAME . (1 st character of model's name is highlighted.)
	Input aircraft's name. Close the MODEL submenu when done.	⌂ to change first character. When proper character is displayed, ⏪ to move to next character and repeat. Ⓜ to return to BASIC menu.
REVERSE servos as needed for proper control operation. P. 26.	In the BASIC menu, open (servo) REVERSE .	⏪ to REVERSE . ⌂ to choose REVERSE .
	Choose desired servo and reverse its direction of travel. (Ex: reverserudder servo.)	⏪ to CH4:RUDD . ⌂ so REV is highlighted. Are you sure? Displays. ⌂ for 1 second. Repeat as needed. Ⓜ to return to BASIC menu.

GOAL of EXAMPLE:	STEPS:	INPUTS:
Adjust travels as needed to match model's recommended throws (usually listed as high rates).P. 27.	In the BASIC menu, choose END POINT .	 to END POINT .  to choose END POINT .
	Adjust the servos' end points. (Ex: flap servo) Close the function.	 to FLAP .  VR(A)  until travel as desired.  VR(A) . Repeat as needed. 
Set up dual/triple rates and exponential (D/R,EXP) P. 42. (Note that in the middle of the left side of the screen is the name of the channel and the SWITCH position you are adjusting. Two or even three rates maybe set per channel by simply choosing the desired SWITCH and programming percentages with the SWITCH in each of its 2/3 positions.)	Choose D/R,EXP .	 to D/R,EXP .  to choose D/R,EXP .
	Choose the desired control, and set the first (Ex: high) rate throws and exponential.	 to CH> .  to choose CH>2 (elevator).  A to up position. [Note screen reads ELEV (UP)]  to D/R .  ELEVATOR STICK .  to set.  ELEVATOR STICK .  to set. (Normally the same for both directions.)  to EXP .  ELEVATOR STICK .  to set.  ELEVATOR STICK .  to set.
	Set the second (low) rate throws and exponential.	 to D/R .  A to down position. Repeat above to set low rate.
	<i>Optional: change dual rate SWITCH assignment. Ex: elevator to SWITCH G with 3 positions.</i>	 to SW .  to G .  G to center position. Repeat steps above to set 3rd rate. 
Move flap control from the VR(A) dial to the left slider [VR(D)]. (AUX-CH) p. 34.	In the BASIC menu, open AUX-CH .	 to AUX-CH .  to choose AUX-CH .
	Choose CH6 (flap). Change primary control to VR(D) . Change other channels as needed.	 to CH6 .  to VR(D) . Repeat as required.
	Return to the home screen.	 
<i>Where next?</i>	(Other functions you may wish to set up for your model.) TRAINER p. 34. Multiple wing or tail servos. See wing types and tail types: p. 39, 43. OFFSETS, BUTTERFLY(AIRBRAKE/crow) , and other programmable mixes p.47. Retractable Gear, Smoke systems, kill switches, and other auxiliary channel setups: p. 46. Adjusting SUB-TRIMS to match servo centers: p. 36.	

A LOOK AT THE RADIO'S GLID-SPECIFIC FUNCTIONS STEP BY STEP.

Those functions which are identical to the **ACRO** setups are referred directly to those pages.

MODEL TYPE: This function of the **PARAMETER** submenu is used to select the type of model programming to be used.

GLIDER TYPES:

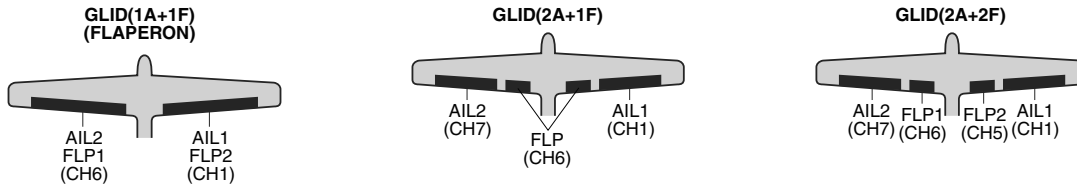

Before doing anything else to set up a glider or sailplane, first you must decide which **MODEL TYPE** best fits your aircraft.

- **ACRO:** for some aerobatic/slope gliders, **ACRO** is a better choice because of functions it offers that the **GLID** types do not.
 - **ACRO** provides:
 - **SNAP-ROLL,**
 - **AILEVATOR** (twin elevator servo support),
 - **AIRBRAKE** (a more assignable version of **BUTTERFLY**).
 - For nitro-powered sailplanes: **IDLE-DOWN, THR-CUT, THROTTLE-NEEDLE** mixing and **THROTTLE DELAY** programming.
 - But **ACRO** lacks programming for full-span ailerons and separate **OFFSET** trims for each flight condition: Normal, Start, Speed, Distance and Landing.
- **GLID(1A+1F):** The **GLID(1A+1F) MODEL TYPE** is intended for sailplanes with one or two aileron servos (or none), and a single flap servo (or two connected with a y-connector). This **TYPE** is meant to be a very simplistic version to set up a basic glider without a lot of added features. Additional flight conditions available.
- **GLID(2A+1F):** The **GLID(2A+1F) MODEL TYPE** is intended for sailplanes with dual aileron servos and a single flap servo (or two connected with a y-connector) Additional flight conditions available. These flight conditions contain different offset trims and aileron differentials to make the sailplane perform certain maneuvers more easily.
- **GLID(2A+2F):** The **GLID(2A+2F) MODEL TYPE** supports dual flap servos that can also act as ailerons, creating full-span ailerons and flaps. Additional flight conditions available. These flight conditions contain different offset trims and aileron differentials to make the sailplane perform certain maneuvers more easily.

GOAL of EXAMPLE:	STEPS:	INPUTS:
Change model1 is MODEL TYPE to GLID(1A+1F) . <i>NOTE: This is one of the several functions that the radio requires confirmation to make a change.</i>	Confirm you are currently using the proper model memory. (Ex: 1)	On home screen, check model name and number on top left. If it is not the correct model (Ex: 1), use MODEL SELECT , p. 22.
	Open PARAMETER submenu.	(MODE) for 1 second. (If ADVANCE , (MODE) again.) ⊙ to PARAMETER . ⚙
	Change the MODEL TYPE . <i>Confirm the change.</i>	⊙ to TYPE . ⚙ to GLID(1A+1F) . ⚙ for one second. Are you sure? Confirmation displays. ⚙ to confirm.
	Close.	(END) (END)

Motor cut function (MOTOR CUT) (GLID): provides an easy way to stop the motor by flipping a switch regardless of the **AIRBRAKE STICK** position. The servo movement is largest at -30%.

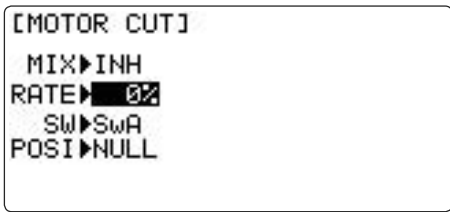

The switch's location and direction must be chosen. It defaults to **NULL** to avoid accidentally assigning it to a switch, which might result in an unintentional dead stick in flight.

Adjustability:

- **RATE** range of -30 to +30. The servo movement at 0% is maximum slow position of **AIRBRAKE STICK**. The servo movement is largest at -30%.
- **SWITCH A-H** fully assignable. Also **LOGIC SW (Lsw1 to 3)** may be assigned.
- **POSITION** fully assignable, including **NULL** (mix always off) and **Up&Cntr** and **Cntr&Dn** to activate the mix in 2 separate positions of the same **SWITCH**.

GOAL of EXAMPLE:	STEPS:	INPUTS:
Decrease the rate to stop the motor with the flip of a switch. (Note that you MUST assign a switch. The default is NULL .)	Open BASIC menu, then open THR-CUT function.	(MODE) for 1 second. (If ADVANCE , (MODE) again.) ⊕ to THR-CUT . ⊗
	Activate the function. Choose desired switch, and the position which activates the function.	⊕ to MIX . ⊗ to OFF or ON . ⊕ to SW . ⊗ to desired switch. ⊕ to POSI . ⊗ to desired position.
		⊕ to RATE . ⊗ until turns off.
	Close.	(END) (END)
<i>Where next?</i>	Set up dual/triple rates and exponential (D/R,EXP): see p. 30. Set up TRAINER functions: see p. 34.	

*Also **LOGIC SW (Lsw1 to 3)** may be assigned. Set up **LOGIC SW**: See p. 26.

GLIDER ADVANCE MENU

Varied wing types and tail types (twin aileron servos, twin elevator servos, elevon, v-tail, etc).

- **FLAPERON (GLID 1A+1F only)**: 2 aileron servos operate in opposite directions as ailerons and same direction as flaps.
- **CAMBER FLAP**: provides camber movement or trimming of flaps.
 - For sailplanes, this function is also used as wing camber. The amount depends on the model, but usually a small amount (less than 10%) is preferred, since too much camber produces excess drag. Don't use more than about 1/16" travel up or down for glider camber. Some airfoils, such as the RG-15, should be flown with NO reflex/camber. Be sure to consult your model's manual for guidelines.
 - Note that even though you may make **CAMBER FLAP** active while using **AILE-DIFF**, it will not have any effect. The ONLY function that allows control of the ailerons as flaps in the **AILE-DIFF** configuration is airbrake/butterfly.)
- **Aileron Differential (AILE-DIFF)**: allows twin aileron servos to provide differential down travel from up travel.
- **Using a 5-channel receiver with FLAPERON and AILE-DIFF.**
- **ELEVON**: for flying wings.
- **V-TAIL**: for models with 2 servos operating together to create roll and pitch control.
- **AILEVATOR**: not available in **GLID** model types.

Mixes:

- **Linear Programmable mixes (PROG.MIX1-4):** fully assignable programmable mixes with a linear response.
- **Curved Programmable mixes (PROG.MIX5-8):** fully assignable programmable mixes with a curved response.
- **ELEV-FLAP:** pre-programmed mix creates elevator movement from the inboard flaps as well as elevators.
- **BUTTERFLY:** Often called crow, **BUTTERFLY** is the glider version of **AIRBRAKE**. (**BUTTERFLY** does not have the option to activate it solely from a switch, and its activation switch. It always provides progressively more **BUTTERFLY** as the **CHANNEL 3 (THROTTLE) STICK** is lowered, or raised if used **THR-REV**) See **AIRBRAKE**.

Full Span Mixing: Flap-to-Aileron and Aileron-to-Flap

- **CAMBER-MIX/AILE-FLAP:** This pre-programmed mix is used to create full span flap/aileron action on a glider with 4 wing servos. This changes the camber over the entire wing, which produces less drag than just dropping the flaps by themselves.

NOTE: When you have **ELEV-FLAP** mixing also, the trailing edge droops with the elevators, increasing pitch response.

AILE/RUDD(GLID):

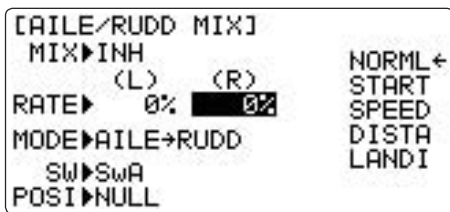

You can select a pre-programmed mix which is used to mix the rudders with aileron operation or the ailerons with rudder operation.

Aileron-to-rudder mix (**AILE→RUDD**): automatically creates a "coordinated turn".

Rudder -to-aileron mix (**RUDD→AILE**): used to counteract undesirable roll (roll coupling) that happens with rudder input, especially in knife-edge.

Adjustability:

- **RATE** range of -100 to +100. Negative setting would result in opposite rudder (aileron) action from aileron (rudder).
- **SWITCH A-H** fully assignable. Also **LOGIC SW (Lsw1 to 3)** may be assigned. Set up **LOGIC SW**: See p. 26.
- **POSITION** fully assignable, including **NULL** (mix always on) and **Up&Cntr** and **Cntr&Dn** to activate the mix in 2 separate positions of the same **SWITCH**.
- **Condition:** The separate **AILE/RUDD** settings for each flight condition can be set.

GOAL of EXAMPLE:	STEPS:	INPUTS:
Ex: RUDD→AILE, 25%, no switch, corrects roll coupling.	Open AILE/RUDD mix submenu.	(MODE) for 1 second. (If BASIC , (MODE) again.) ⊙ to AILE/RUDD . ☀
	Select the mixing mode.	⊙ to MODE . ☀ to RUDD→AILE
	Activate the function.	⊙ to MIX ☀ to ON .
	Set the rate. (Ex: 100% each way)	⊙ to FLP1 . ☀ RUDDER STICK . ☀ to +25% . ☀ RUDDER STICK . ☀ to +25% .
	Repeat as needed.	
	Close.	(END) (END)
<i>Where next?</i>	ELEV-FLAP mixing. See p. 48. BUTTERFLY . See p. 48. Use a mix to OFFSET the flaps a set distance on a specified switch: see p. 68. View additional model setups on the internet: www.radiolink.com.cn/doce .	

AILE-FLAP (GLID 2A+2F only):

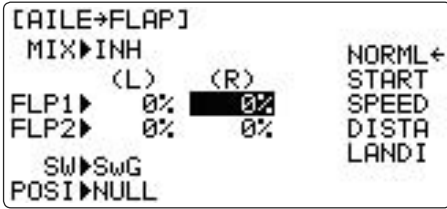

This pre-programmed mix is used to create full span aileron action on a glider with 4wing servos. This increases the roll rate and decreases induced drag. For normal flying, a value of about 50% is often used. For slope racing or F3B models in speed runs, you may wish to use a larger value approaching 100%.

Adjustability:

- **RATE** range of -100 to +100. Negative setting would result in opposite aileron action from flaps.
- **SWITCH A-H** fully assignable. Also **LOGIC SW (Lsw1 to 3)** may be assigned. Set up **LOGIC SW**: See p. 26.
- **POSITION** fully assignable, including **NULL** (mix always on) and **Up&Cntr** and **Cntr&Dn** to activate the mix in 2 separate positions of the same **SWITCH**.
- *Condition:* The separate **AILE-FLAP** settings for each flight condition can be set.

GOAL of EXAMPLE:	STEPS:	INPUTS:
Turn on AILE-FLAP mixing. Set rate to 100% for maximum possible flap travel with ailerons. Assign to SWITCH C center.	Open AILE-FLAP submenu.	(MODE) for 1 second. (If BASIC , (MODE) again.) ⬆ to AILE-FLAP . ⚙
	Activate the function.	⬆ to MIX ⚙ to ON .
	Set the rate. (Ex: 100% each way)	⬆ to FLP1 . ⬆ AILERON STICK . ⚙ to +100% . ⬆ AILERON STICK . ⚙ to +100% . Repeat above to set FLP2 .
	Assign the SWITCH and position.	⬆ to SW . ⚙ to C . ⬆ to POSI . ⚙ to CENTER .
	Close.	(END) (END)
<i>Where next?</i>	ELEV-FLAP mixing. See p. 48. BUTTERFLY . See p. 48. Use a mix to OFFSET the flaps a set distance on a specified switch: see p. 68. View additional model setups on the internet: www.radiolink.com.cn/doce .	

SPOILER MIX (GLID): moves the spoiler(s) by flipping the assigned switch and is used to make steep descents. And **SPOILER MIX** works linking with **BUTTERFLY** function.

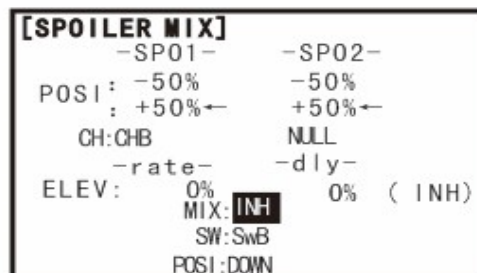

Adjustability:

- **Position:** -100% to +100%, with a default of -50% (off), +50% (on)
- **Channel:** Spoiler 1: ch8, or 3 (ch8 or 3*), Spoiler 2: NULL, or 3 (NULL or ch3*) *GLID (2A+2F) mode
- **Elevator setting:** Rate: -100% to +100%, Delay: 0% to 100%
- **SWITCH A-H** fully assignable. Also **LOGIC SW (Lsw1 to 3)** may be assigned. Set up **LOGIC SW:** See p. 26.

GOAL of EXAMPLE:	STEPS:	INPUTS:
2-servo spoiler mode. Adjust the spoiler servo position to 60% .	Open the SPOILER MIX function and move to 2nd page.	(MODE) for 1 second. (If BASIC , (MODE) again.) ⌂ to SPOILER MIX . ⌂
	Activate the function.	⌂ to MIX . ⌂ to ON .
	Assign the SPO2-CH. (Ex: CH3)	⌂ to SPO2-CH. ⌂ to CH3 .
	Adjust the spoiler servo position. (Ex: SPO1/SPO2=+55% to +60%)	⌂ to +50%. (SPO1) ⌂ to +60% . ⌂ to +50%. (SPO2) ⌂ to +60% .
	<i>Optional: Set the elevator rate. (EX: 10%)</i>	⌂ to rate-ELE. ⌂ to 10% .
	<i>Optional: Set the delay. (EX: 25%)</i>	⌂ to dly-ELE. ⌂ to 25% .
Close menu.	END END	
Where next?	Set up BUTTERFLY mixing: see p. 68.	

OFFSETS: additional flight conditions available specifically for sailplanes.

[OFFSET]	-rate-	-dly-	
ELEV▶	0%	▶ 0%	norm1
RUDD▶	0%	▶ 0%	START←
AIL1▶	0%	▶ 0%	SPEED
2▶	0%	▶ 0%	DISTA
FLP1▶	0%	▶ 0%	LANDI
2▶	0%	▶ 0%	

These additional flight conditions contain different offset trims to make the sailplane perform certain maneuvers more easily. Aileron differential functions may be set to provide separate rates per condition selected.

Prior to setting up **OFFSET**, you must active the conditions and assign the switches in the **CONDITION/FUNCTION**.

Unnecessary fuselage motion is generated when there are sudden changes in the servo position and variations in the operating time between channels can be suppressed by using the delay function (**-dly-**).

NOTE: The same delay amount for elevator and rudder is recommended when using V-tail function.

The 10C provides 4 offset trims to allow the modeler 4 additional setups along with the normal flight condition. (**NORMAL, START, SPEED, DISTANCE** and **LANDING**) These offset trims have same setting abilities basically except the switch and dial assignment. For an example of trim settings, please see the following:

Adjustability:

- Separate adjustments for each aileron, elevator, rudder and flap servo, for each condition.
- **SWITCH G** (AT10) or **E** (AT10) is programmed for **NORMAL, START, and SPEED** trims. **SWITCH C** is programmed for **DISTANCE** and **LANDING** trims. These switch/position assignment is adjustable. (**CONDITION/FUNCTION**)
- **TRIM** item (Digital trim operation mode):

[CONDITION.	-sw-	-pos-
START▶INH	▶E	▶DOWN
SPEED▶INH	▶E	▶UP
DISTANCE▶INH	▶C	▶CENTER
LANDING▶INH	▶C	▶DOWN
ARBK-FUNC▶STICK		

NORM: normal trim operation mode,

MIX: offset rate trim operation mode while mixing is on.

- Optional assignable knob (**CAMBER MIX**) to allow trimming in flight of the aileron and flap action of each flight condition.

*During **OFFSET** operation, the aileron and elevator travels are displayed on each trim display in the Startup screen.

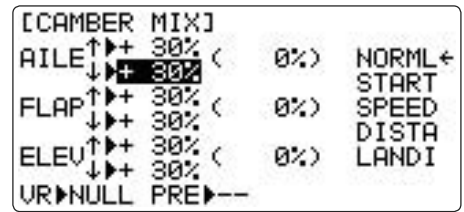

GOAL of EXAMPLE:	STEPS:	INPUTS:
Set up a START to gain maximum possible lift on launch. Each Aileron: 50%. Each Flap: 100%. Elevator: -5% to compensate. SWITCH (AT10= <i>G</i> , AT10= <i>E</i> .) Note: switch is assignable. (CONDITION) KNOB (null) Note: knob is assignable. (CAMBER MIX)	Open OFFSET function.	(MODE) for 1 second. (If BASIC , (MODE) again.) ⌂ to OFFSET . ⌂
	Switch to the START condition.	⌂ <i>G</i> (AT10) or <i>E</i> (AT10) from NORMAL to START .
	Set the rates. (Ex: AIL1 and 2 , 50% , FLP1 and 2 , 100% , ELEV -5% .)	⌂ to AIL1 . ⌂ to +50% . ⌂ to AIL2 . ⌂ to +50% . Repeat for, FLP1 and 2 , ELEV .
	Close the function.	(END) (END)
Where next?	View additional model setups on the internet: www.radiolink.com.cn/doce .	

START DELAY (GLID 1A+1F only):

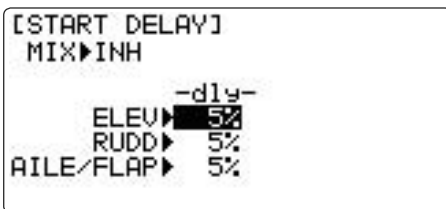

START DELAY automatically switch the offset trims (**OFFSET**) from the **START** condition's trims to the normal condition's trims after proceeding the delay time (max.10sec.) which is set by the **-dly-** item when activating the **START** condition. (It is convenient for hand launch glider.)

NOTE: The same delay amount for elevator and rudder is recommended when using V-tail function.

Adjustability:

- Delay time (**-dly-**) range of 0 to 100%. The delay time is 10 second at 100%.

GOAL of EXAMPLE:	STEPS:	INPUTS:
Ex: delay time=5 second.	Open ADVANCE menu, then open START DELAY function.	(MODE) for 1 second. (If ADVANCE , (MODE) again.) ⌂ to START DELAY . ⌂
	Activate the function.	⌂ to MIX . ⌂ to OFF or ON .
	Set the delay time. (Ex: 50% each surface)	⌂ to ELEV . ⌂ to 50% . ⌂ to RUDD . ⌂ to 50% . Repeat as needed.
	Close.	(END) (END)

Camber Mixing (**CAMBER MIX**)(GLID):

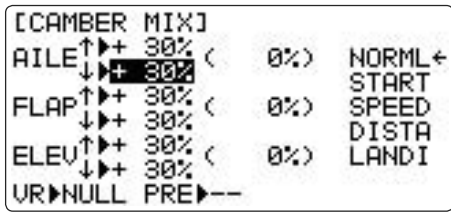

This function adjusts the mixing rate of camber operation which operates the wing camber (ailerons and flaps) in the negative and positive directions. The aileron, flap, and elevator rates can also be adjusted independently and attitude changes caused by camber operation can be corrected.

Also the operation reference point of camber control can be offset. (**PRE**)

NOTE: Camber control is not assigned at initial.

Adjustability:

- **Rate:** -100% to +100%, with a default of +30%
- **Reference point (PRE):** The operation reference point of camber control can be offset. -100% to +100%, with a default of 0%.

GOAL of EXAMPLE:	STEPS:	INPUTS:
Ex: Set the mixing amount for aileron to 40% , camber control to VR(E) , reference point to desired point.	Open the CAMBER MIX function.	MODE for 1 second. (If BASIC , MODE again.) ⊕ to CAMBER MIX . ☀
	Choose desired slider.	⊕ to VR . ☀ to VR(E) .
	Adjust the mixing amount for AILE . (Ex: adjust to 40% .)	⊕ to AILE . ☀ VR(E) . ☀ to 40% . ☀ VR(E) . ☀ to 40% .
	Set the reference point.	⊕ to PRE . ☀ or ☀ VR(E) to desired point. ☀ for one second.
	Close menu.	END END

Flap Setting (**CAMBER FLAP**)(GLID):

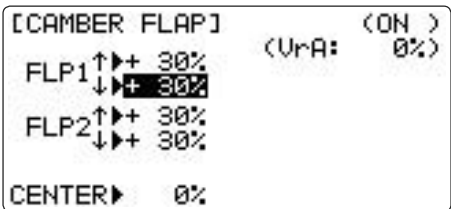

CAMBER FLAP assigns the primary flap control [defaults to **VR(A)**] to allow trimming in flight of the flap action.

The up/down travel of each flap (camber flaps: **FLP1/2**) can be adjusted independently. Also the center position of flap servo can be offset.

NOTE: If **FLAP-TRIM** is activated, you can not use **CAMBER FLAP** function simultaneously.

Adjustability:

- **Rate:** -100% to +100%, with a default of +30%
- **Center position (CENTER):** The operation reference point of flap can be offset. -100% to +100%, with a default of 0%.

[Note] When changing the polarity of a rate, "change rate dir?" is displayed for a check. Please set up after pressing **DIAL** for 1 second and canceling an alarm display.

GOAL of EXAMPLE:	STEPS:	INPUTS:
Ex: Set the maximum travel of 35% of the total flap travel.	Open the CAMBER FLAP function.	MODE for 1 second. (If BASIC , MODE again.) ⊕ to CAMBER FLAP . ☀
	Adjust the up/down trim amount separately. (Ex: adjust to 35% .)	⊕ to FLP1 . ☀ VR(A) . ☀ to 35% . ☀ VR(A) . ☀ to 35% . Repeat.
	<i>Option: Adjust the center position of flap servo.</i>	⊕ to CENTER . ☀ to desired point.
	Close menu.	END END

BUTTERFLY (crow) mixing (GLID):

[BUTTERFLY]

AIL1: 0%	MIX: INH
AIL2: _____	SW: SwA
FLAP: 0%	: DOWN
SPO1: _____	CRI: 1
PRESET: 15% (13%)	

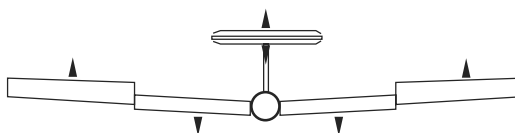

BUTTERFLY (often called "crow"- see **GLID** p63for details) simultaneously moves the flap, twin ailerons and elevator, and is usually used to make steep descents or to limit increases in airspeed in dives. Separate two **BUTTERFLY** settings are available. (**CIR1/CIR2**)

Adjustability:

- **Activation:** Proportional by moving the **THROTTLE STICK**.
- **Switch:** Mix **SWITCH** is selectable.

A to H: **SWITCH A** to **H**

NULL: always on.

Also **LOGIC SW (Lsw1 to 3)** may be assigned. Set up **LOGIC SW:** See p. 26.

- **Inversely proportional to THROTTLE STICK:** provides a proportional increase in amount of airbrake action as **THROTTLE STICK** is lowered (when **SWITCH A** (assignable) is in down position). Includes selectable stick position where airbrake begins. If you would like to have the airbrake be directly proportional to throttle stick, you will need to reverse the **THR-REV** function. Note that this changes the throttle stick direction for all models. See page 26 for instructions.

- **Elevator settings:** (adjustable in the **B.FLY-ELE**)

B.FLY-ELE works linking with **BUTTERFLY** function. Elevator rate is adjustable in a 3 point curve.

Point 1: **PRESET** point. (Fixed)

Point 2: **MID** point. Position and rate are adjustable.

Point 3: **END** point. Position and rate are adjustable.

- **Delayed reaction:** You can suppress sudden changes in your model's attitude when **BUTTERFLY** is activated by setting the delay (**DELAY**) item, to slow down the elevator response, allowing the flaps/ailerons/elevator to all reach their desired end point together. A setting of **100%** slows the servo to take approximately one second to travel the prescribed distance.
- **Channels controlled:** Twin ailerons, flap and spoiler may be set independently in **BUTTERFLY**, including set to **0** to have no effect.
- **Twin aileron servos:** If **AIL-DIFF** function is inhibited, then **AIL1** and **AIL2** settings will have no effect.
- If **AIL-DIFF** is active, then CH1 and CH7 may be independently adjusted.
- Normally both ailerons are raised equally in **BUTTERFLY**, and the elevator motion is set to maintain trim when the ailerons rise. Different amounts may be set for each aileron to correct for torque reactions and other unique characteristics of the model.

[CONDITION]

	-sw-	-Pos-
START	▶INH	▶SwE ▶DOWN
SPEED	▶INH	▶SwE ▶UP
DISTANCE	▶INH	▶SwC ▶CENTER
LANDING	▶INH	▶SwC ▶DOWN
ARBK-FUNC	▶STICK	

[B.FLY→ELEV]

		MIX▶1(-)
	-rate-	-Posi-
MID	▶0%	▶55%
END	▶0%	▶95% (50)
DELAY	▶0%	

⚠ Be sure you understand what dropping ailerons will do when in **BUTTERFLY**. Along with creating an enormous amount of drag (desireble for spot landings), this also creates "wash-in", a higher angle of attack where the ailerons are, and encourages tip stalling. If you are using this for aerobatic performance and not "sudden stops", consider raising the ailerons and dropping the flaps instead as shown in the diagram above.

GOAL of EXAMPLE:	STEPS:	INPUTS:
Activate BUTTERFLY . Adjust the aileron and flap travel to 75% . Elevator settings are adjustable in the B.FLY-ELE . Mix switch is selectable.	Open the BUTTERFLY function.	(MODE) for 1 second. (If BASIC , (MODE) again.) ⌂ to BUTTERFLY . ⌂
	Activate the function.	⌂ SWITCH A in up position. ⌂ to MIX ⌂ to OFF .
	Adjust the travels as needed. (Ex: Ailerons each 75% , Flap 75% .)	⌂ to AIL1 ⌂ to 75% . ⌂ to FLAP ⌂ to 75% . ⌂ to AIL2 ⌂ to 75% .
	Close menu.	(END) (END)
Where next?	View additional model setups on the internet: www.radiolink.com.cn/doce .	

Channel 3's function selection (CONDITION/FUNCTION):

```

[CONDITION.
  START▶INH ▶E ▶DOWN
  SPEED▶INH ▶E ▶UP
  DISTANCE▶INH ▶C ▶CENTER
  LANDING▶INH ▶C ▶DOWN
  ARBK-FUNC▶STICK

```

Channel 3's function is selectable in the **ARBK-FUNC** item. (Throttle stick, switches, or knobs)

By choosing except **STK**, channel 3's function may be separated from **BUTTERFLY's** function, so channel 3 can be used for other functions.

Adjustability:

- Channel 3's function:

STK: THROTTLE STICK

Sw-A to H: SWITCH A to H

Vr-A to Vr-E: KNOB A to E

HELICOPTER MODEL FUNCTIONS

Please note that nearly all of the **BASIC** menu functions are the same for airplane (**ACRO** setup), sailplane (**GLID** setups), and helicopter (**HELI**) setups. The features that are identical refer back to the **ACRO** chapter. The Helicopter **BASIC** menu includes the normal condition's throttle and collective pitch curves and revo. mixing. (idle-ups and throttle hold are advanced features and are in the **ADVANCE** menu).

HELICOPTER FUNCTIONS.....	70	HELI ADVANCE MENU FUNCTIONS	79
Table of contents and reference info for helicopters .	70	THROTTLE HOLD	79
Getting Started with a Basic Helicopter	71	THR-CURVE, PIT-CURVE and REVO	80
HELI BASIC MENU FUNCTIONS	73	Idle-ups.....	81
MODEL Submenu: MODEL SELECT, COPY, NAME	20	Trims/offset	81
PARAMETER Submenu: RESET, MODUL, ATL, AILE-2,		Delay.....	83
CONTRAST, BACK-LIGHT, HOME-DISP, USER NAME, LOGIC		Hovering setups	84
SW	23	High/low pitch	84
MODEL TYPE (PARAMETERS submenu)	74	Gyros and governors	85
Servo REVERSE	26	Mixes: definitions and types	47
SWASH AFR (swashplate surface direction and travel		Linear, Prog. mixes 1-4	53
correction) (not in H-1).....	75	Curve, Prog. mixes 5-8	55
THROTTLE MIX	76	THROTTLE-NEEDLE	50
END POINT	27		
Setting up the Normal Flight Condition	77		
THR-CUT (specialized settings for helicopter specific			
models).....	78		
Dual/Triple Rates and Exponential (D/R, EXP).....	30		
TIMER Submenu.....	33		
Auxiliary Channel assignments and CH9 reverse (AUX-			
CH).....	34		
TRAINER	34		
TRIM and SUB-TRIM	36		
SERVO Display	37		
Fail Safe and Battery FailSafe (F/S).....	38		

GETTING STARTED WITH A BASIC HELICOPTER















































This guideline is intended to help you set up a basic (**H-1**) heli, to get acquainted with the radio, to give you a jump start on using your new radio, and to give you some ideas and direction on how to do even more with this powerful system than you may have already considered. It follows our basic format of all programming pages—a big picture overview of what we're trying to accomplish; a “by name” description of the steps to help acquaint you with the radio; and then a step-by-step instruction to leave out the mystery and challenge of setting up your model.









Briefly, the typical helicopter's controls are as follows:

- **Aileron:** changes cyclic lateral (roll) . Rolls the helicopter. Tilts the swashplate to the left or right. CH1.
- **Elevator:** changes cyclic pitch. Changes the helicopter's angle of attack (nose up or nose down). Tilts the entire swashplate fore and aft. CH2.
- **Rudder:** changes the angle of the tail rotor. Yaws the helicopter left or right. CH4.
- **Collective Pitch:** adjusts main rotor collective [angle of the paddles], changing the main blades' pitch. Increased collective pitch (with throttle) causes the helicopter to rise. Moves in conjunction with throttle on the **THROTTLE STICK**. CH6.
- **Throttle:** opens/closes carburetor. Moves in conjunction with collective pitch on the **THROTTLE STICK**. CH3.
- **REVO:** mix that adds rudder in conjunction with pitch. This helps compensate for rotation of the helicopter caused by the increased engine torque. (Never use revo. mixing with a heading-hold/AVCS gyro; the gyro already does this.)

For additional details, see that function's section in this manual—the page numbers are indicated in the first column for you.

GOAL of EXAMPLE:	STEPS:	INPUTS:
Prepare your helicopter.	Install all servos, switches, receiver per your model's instructions. Set all trims, dials and sliders to neutral. Confirm all control linkages are 90 degrees (or per instructions) from the servo horn to the ball link for proper geometry and that no slop is present. Mechanically adjust all linkages to get as close as possible to proper control throws and minimize binding prior to radio set up.	
Select the proper MODEL TYPE for your model. Ex: HELI (H-1) . See p. 73. <i>[NOTE: This is one of several functions for which the radio requires confirmation to make a change. Only critical changes require additional key strokes to accept the change.]</i>	In the BASIC menu, open the PARAMETER submenu.	Turn on the transmitter. for 1 second. (If ADVANCE , again.) then to highlight PARAMETER . to choose PARAMETER .
<i>Only critical changes require additional key strokes to accept the change.]</i> (If the correct model type was already displayed, be sure to do a model reset to discard any unwanted settings.)	Go to MODEL TYPE . Select proper MODEL TYPE . Ex: HELI(H-1) . Confirm the change. Close PARAMETER .	to TYPE . to HELICOPTER . for 1 second. Are you sure? displays. to confirm. to SWASH . to H-1 . for 1 second. Are you sure? displays. to confirm. to return to BASIC menu.
Then, NAME the model. P. 22. <i>(You do not need to do anything to “save” or store this data.)</i>	In the BASIC menu, open the MODEL submenu. Go to MODEL NAME . Input aircraft's name. Close the MODEL submenu when done.	as needed to highlight MODEL . to choose MODEL . to NAME . (First character of model's name is highlighted.) to change first character. When proper character is displayed, to move to next character. Repeat. to return to BASIC menu.

GOAL of EXAMPLE:	STEPS:	INPUTS:
Reverse servos as needed for proper control operation. Ex: LEFT RUDDER STICK results in leading edge of tail rotor blades moving left. Reverse to operate properly. P. 38.	In the BASIC menu, open REVERSE . Choose desired servo and reverse its direction of travel. (Ex: reverse rudder servo.)	 to REVERSE .  to choose REVERSE .  to CH4:RUDD .  so REV is highlighted. Are you sure? Displays.  for 1 second. Repeat as needed.  to return to BASIC menu.
Adjust Travels as needed to match model's recommended throws (usually listed as high rates).P. 39.	In the BASIC menu, choose END POINT . Adjust the servos' end points. (Ex: elevator servo) Return to BASIC menu.	 to END POINT .  to choose END POINT .  to ELEV .  ELEVATOR STICK .  until up travel is as desired.  ELEVATOR STICK .  until down travel is as desired. Repeat as needed. 
Activate THR-CUT . P. 78.	Open THROTTLE-CUT function. Activate the function. Choose desired switch and position to activate. With THROTTLE STICK at idle, adjust the rate until the engine consistently shuts off, but throttle linkage is not binding. ¹ Close.	 to THROTTLE-CUT .  to choose THR-CUT .  to MIX  to OFF .  to SW .  to C .  to POSI .  to DOWN .  C to down position.  THROTTLE STICK .  to RATE .  until shuts off. 
Set up throttle curve for normal. ² (Usually changes will not need to be made prior to first flight.) P. 77	Open the THR-CURV/NOR function. Adjust if needed. Close the function.	 to THR-CURV/NOR .  .  to 1> .  to 5% .  to next point. Repeat. 
Set up collective pitch curve for normal as base of -4, center of +5, end of +8 to +10 degrees of blade pitch for aerobatics. ² (If just learning to fly, ask your instructor.) P. 78.	Open the PIT-CURV/NOR function. Adjust each point to match desired curve. (Ex first point: 8% .) Close the function.	 to PIT-CURV/NOR .  .  to 1> .  to 8% .  to next point. Repeat. 
Set up revo. mixing for normal. (For heading-hold gyros, inhibit revo.) P. 78.	Open the REVO./NOR function. Adjust to your desired starting point. (Ex: 10% .) Close the function.	 to REVO./NOR .  .  to 1> .  to 10% .  to next point. Repeat.  
Confirm Gyro direction.	With radio on, move helicopter's tail to the right by hand. The gyro should give right rudder input (leading edge of the tail rotor blades move left). If the gyro gives the opposite input, reverse direction on the gyro unit itself.	

GOAL of EXAMPLE:	STEPS:	INPUTS:
Learn how to operate HOVERING PITCH and HOVERING THROTTLE	Notice at half throttle, the <i>VR(C)</i> dial adjusts the throttle separately from the pitch. <i>VR(A)</i> adjusts the pitch separately from the throttle.	 for 1 second. (If ADVANCE ,  again.)  to SERVO .   throttle to center  <i>VR(C)</i>  <i>VR(A)</i> center dials.  
Be sure to follow your model's instructions for preflight checks, blade tracking, etc. Never assume a set of blades are properly balanced and will track without checking.		
⚠ <i>Check receiver battery voltage! Always check voltage with a voltmeter prior to each and every engine start. (Never assume being plugged in all night means your radio gear is ready to fly). Insufficient charge, binding servo linkages, and other problems can result in a dangerous crash with the possibility of injury to yourself, others and property.</i>		
Confirm the swashplate is level at 0 travel. Adjust arms if needed.		
Apply full collective and check that the swashplate remained level and there is no binding. Repeat for full cyclic pitch and roll. If not, adjust as needed to correct in END POINT : see p. 27.		
Important note: prior to setting up throttle hold, idle-ups, offsets, etc, be sure to get your normal condition operating properly.		
Checking setup prior to going airborne: Check voltage! Then, with the assistance of an instructor, and having completed all range checks, etc, gradually apply throttle until the helicopter becomes "light on the skids." Adjust trims as needed to correct for any roll, pitch, or yaw tendencies. If the tail "wags," the gyro gain is too high. Decrease gyro gain.		
<i>Where next? (Other functions you may wish to set up for your model.)</i>		
THROTTLE HOLD : P. 79. SUB-TRIM p. 36 and separate trims for conditions (OFFSETS): p. 82. Governor setup: p. 87. IDLE-UP p. 81. DELAYS to ease servo response when switching idle-ups: p. 82. Rudder-to-throttle and other programmable mixes p. 53.		

¹ Periodically move the throttle stick to full and back down to ensure proper servo settings.

² It is critical that dials *A* and *C* be centered when the pitch and throttle curves are setup.

HELI-SPECIFIC BASIC MENU FUNCTIONS

MODEL TYPE: This function of the **PARAMETER** submenu is used to select the type of model programming to be used. Before doing anything else to set up your model, first you must decide which **MODEL TYPE** best fits your aircraft.

HELICOPTER SWASHPLATE TYPES:

The AT10 radios support 8 basic swashplate setups, including "single servo" (**H-1**-most helicopters use this type) and 7 types of CCPM (cyclic and collective pitch mixing). A "single servo" swashplate uses one servo for each axis: aileron, elevator (cyclic pitch), and collective pitch. CCPM helicopters utilize a combination of servos working together to achieve the 3 axes of motion. There are 7 basic CCPM types, displayed below. CCPM has several advantages, the most obvious of which is far less mechanical complexity to properly move the swashplate of the helicopter. Additionally, several servos working in unison (ex: HR3, all 3 servos together create elevator movement) dramatically increases the torque available as well as the precision and centering.

Please note that some helicopters are type **HR3** or **HN3**, except off by 180 degrees. If your model's swashplate is off by 180 you will still use that swashplate type, but also use **SWASH AFR** to adjust the functions as needed until it operates properly. Additionally, different angles of CCPM may also be created utilizing the fully assignable programmable mixes. (See our Frequently Asked Questions area at www.radiolink.com.cn/doce/.)

Not operating quite like you expected? In many CCPM installations you need to either reverse the direction of a specific function (**SWASH AFR**) or reverse a single servo's direction (**REVERSE**). See **SWASH AFR** for details. (p.75)

Swashplate Types

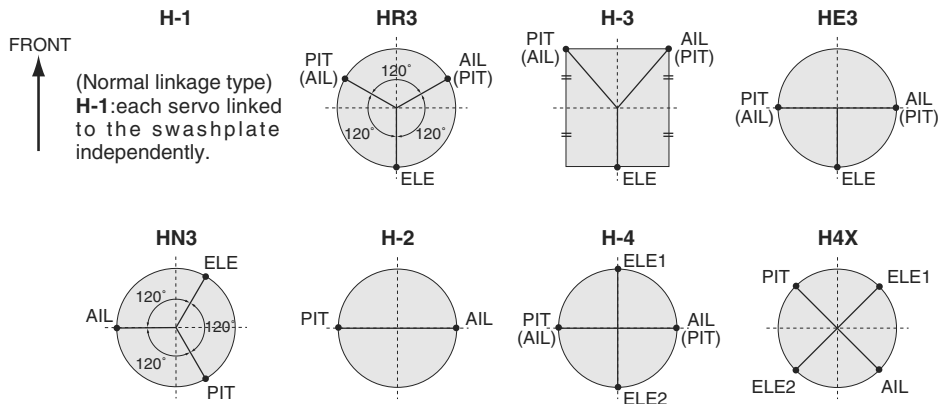

HELI-SPECIFIC BASIC MENU FUNCTIONS

MODEL TYPE: This function of the **PARAMETER** submenu is used to select the type of model programming to be used. Before doing anything else to set up your model, first you must decide which **MODEL TYPE** best fits your aircraft. If your transmitter is a AT10, the default is **ACRO**. If it is a 10CH, the default is **HELI(H-1)**.

HELICOPTER SWASHPLATE TYPES:

The AT10 radios support 8 basic swashplate setups, including "single servo" (**H-1**-most helicopters use this type) and 7 types of CCPM (cyclic and collective pitch mixing). A "single servo" swashplate uses one servo for each axis: aileron, elevator (cyclic pitch), and collective pitch. CCPM helicopters utilize a combination of servos working together to achieve the 3 axes of motion. There are 7 basic CCPM types, displayed below. CCPM has several advantages, the most obvious of which is far less mechanical complexity to properly move the swashplate of the helicopter. Additionally, several servos working in unison (ex: HR3, all 3 servos together create elevator movement) dramatically increases the torque available as well as the precision and centering.

Please note that some helicopters are type **HR3** or **HN3**, except off by 180 degrees. For example, the Kyosho® Caliber is **HR3** but with the 2 parallel servos to the rear of the helicopter, not front. If your model's swashplate is off by 180 degrees, you will still use that swashplate type, but also use **SWASH AFR** (p.75) to adjust the functions as needed until it operates properly. Additionally, different angles of CCPM may also be created utilizing the fully assignable programmable mixes. (See our Frequently Asked Questions area at www.radiolink.com.cn/doce/.)

Not operating quite like you expected? In many CCPM installations you need to either reverse the direction of a specific function (**SWASH AFR**) or reverse a single servo's direction (**REVERSE**). See **SWASH AFR** for details. (p.75)

Swashplate Types

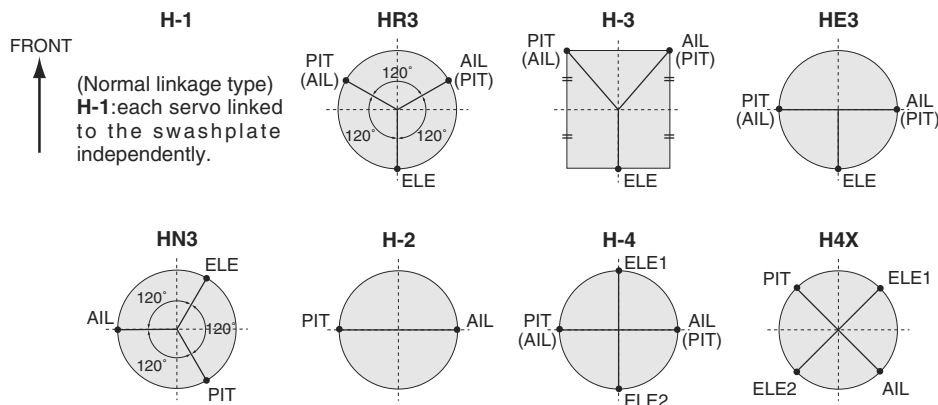

GOAL of EXAMPLE:	STEPS:	INPUTS:
Change the MODEL TYPE and SWASH TYPE of model #3 from aircraft to 120 degree CCPM with 2 servos working in unison for collective pitch and aileron [HELI(HR3)].	Confirm you are currently using the proper model memory. (example: 3)	On home screen, check model name and # on top left. If it is not the correct model (example:3), see MODEL SELECT , p. 20.
	Open PARAMETER submenu.	(MODE) for 1 second. (If ADVANCE , (MODE) again.) ⌂ to 2nd page of menu. ⌂ to PARAMETER . ⌂
	Select proper MODEL TYPE . (HELICOPTER) <i>Confirm the change.</i>	⌂ to TYPE . ⌂ to HELICOPTER . ⌂ for 1 second. Are you sure? displays. ⌂ to confirm. ¹
	Change to the desired SWASH TYPE (example, HR3.) <i>Confirm the change.</i>	⌂ to SWASH . ⌂ to HR3 . ⌂ for 1 second. Are you sure? displays. ⌂ to confirm.
	Close.	(END) (END)
Where next?	If a single servo is not operating properly, REVERSE : see p. 26. If a control is operating backwards (i.e. Elevator), see SWASH AFR , p. 75. If unsure see SWASH AFR .	

¹ Radio emits a repeating “beep” and shows progress on screen as the model type is being changed. Note that if the power switch is turned off prior to completion, the model type will not be changed.

SWASH AFR (not in SWH1):

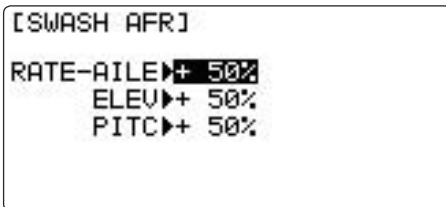

Swashplate function rate settings (**SWASH AFR**) reduce/increase/reverse the rate (travel) of the aileron, elevator (except **H-2**) and collective pitch functions, adjusting or reversing the motion of all servos involved in that function, only when using that function. Since these types utilize multiple servos together to create the controls, simply adjusting a servo's **REVERSE** or **END POINT** would not properly correct the travel of any one control. Since **H-1** uses one servo for each function, there is no need for AFR in **H-1**.

This is fairly hard to explain but easy to see, so let's set up Kyosho® Caliber's swashplate settings as an example. With everything installed per factory instructions, set the model to **HELI(HR3)**. Now let's adjust the swashplate properly.

Since aileron always uses no more than 2 servos, check it first. Either both operate properly (no change needed), both operate backwards (reverse the whole function), or one servo operates backwards (reverse that servo alone).

Next check elevator. Remember, the aileron servo(s) operate correctly, so if elevator does not, we should only have 2 choices left—the whole function needs to be reversed, or the servo(s) not shared with aileron need to be reversed.

Last is collective. If aileron and elevator are working properly, the only thing that could be wrong is the whole direction collective operates (reverse the whole function). In our example, **HR3** is 180 degrees off from the swashplate of the Caliber. Therefore, it is very likely that several functions will not operate properly. The collective pitch operation is backwards; but reversing all three servos would also reverse the aileron and elevator operations. Changing the collective pitch rate, however, from **+50%** to **-50%**, will reverse the collective pitch without affecting the aileron action.

CHECKING FOR PROPER MOTION ON AN HR3 SWASHPLATE			
HR3 Swash Type	PROPER MOTION	WRONG MOTION	HOW TO FIX
AILERON STICK.	Swashplate tilts right.	Swashplate tilts left.	Reverse AIL setting in SWASH to -50% .
		Back of Swashplate moves up.	Ch6 servo moves incorrectly; REVERSE.
		Back of Swashplate moves down.	Ch1 servo moves incorrectly; REVERSE.
ELEVATOR STICK.	Front of swash plate moves down; back of swashplate moves up.	Swashplate moves the opposite.	Reverse ELE setting in SWASH. (ex: +50 to -50)
		Entire swashplate moves up.	Ch2 servo moves incorrectly; REVERSE.
RUDDER STICK.	The leading edges of tail blades rotate left.	Blades rotated right.	REVERSE the rudder servo.
THROTTLE STICK.	Entire Swashplate lifts.	Swashplate lowers.	Reverse PIT setting in SWASH.

GOAL of EXAMPLE:	STEPS:	INPUTS:
Adjust the travel of the collective pitch from +50% to -23% , reversing the travel of all 3 servos and decreasing their travel in collective pitch only, on an HR3 SWASH TYPE.	Open SWASH AFR function.	for 1 second. (If ADVANCE , again.) to SWASH AFR.
	Adjust PITC travel to -23% .	to PITC. to -23% .
	Close the menu.	
<i>Where next?</i>	Confirm the swashplate is level at 0 travel. Adjust arms if needed. Apply full collective and check that the swashplate remained level. If not, adjust servos travels as needed to correct. END POINT: see p. 27. Set up the normal condition: (THR-CURV/NOR, PIT-CURV/NOR, REVO./NORM): see p. 77. Set up D/R,EXP : see p. 30.	

Throttle Mixing (**THROTTLE MIX**):

[THRO MIX]	AIL→TH	ELE→TH	RUDD→TH
MIX: INH			
NORM:	0%	0%	0%
IDL1:	0%	0%	0%
IDL2:	0%	0%	0%
IDL3:	0%	0%	0%

This function can be set for each flight condition, and is used to correct the tendency of the model to change altitude when the rotor is tilted by aileron, elevator, and rudder controls.

Adjustability:

- Mixing may be set from 0 to 100% each flight condition.

GOAL of EXAMPLE:	STEPS:	INPUTS:
Correct the tendency of the model to change altitude.	Open THROTTLE MIX function.	for 1 second. (If BASIC , again.) to ADVANCE menu. to THROTTLE MIX.
	Activate the function.	to MIX to ON.
	Adjust the rate. Ex: IDL1 (AIL to TH) 10%	to IDL1 (AIL to TH) to 10%.
	Repeat as needed.	
	Close the menu.	
<i>Where next?</i>	HI/LOW-PIT : see p. 84. GOVERNOR set up: see p. 87.	

Setting up the Normal Flight Condition: The Normal flight condition is typically utilized for hovering. The throttle and collective pitch curves are adjusted to provide consistent engine RPM despite the increase/decrease in collective pitch of the blades. This keeps the engine from “bogging down” under excessive load (like trying to accelerate a car on a steep hill in 5th gear) or excessive RPM under insufficient load (like flooring the throttle while in neutral), risking engine damage. As the 2 curves and revo. mixing are all interrelated, we will discuss all three first, then complete a sample setup.

Note that the normal throttle, pitch and revo curves are all available in the **BASIC** menu for simplicity. These may also be updated later in the **ADVANCE** menu with the settings for the other 4 conditions [idle-up 1 (**IDL1**), idle-up 2 (**IDL2**) and idle-up 3 (**IDL3**), plus throttle hold (**HOLD**)]. Note: The throttle and pitch curves for the normal condition are always on. They cannot be inhibited. The other four conditions are activated with their throttle curves or throttle hold. For idle-ups, see p. 81. For throttle hold, see p. 79.

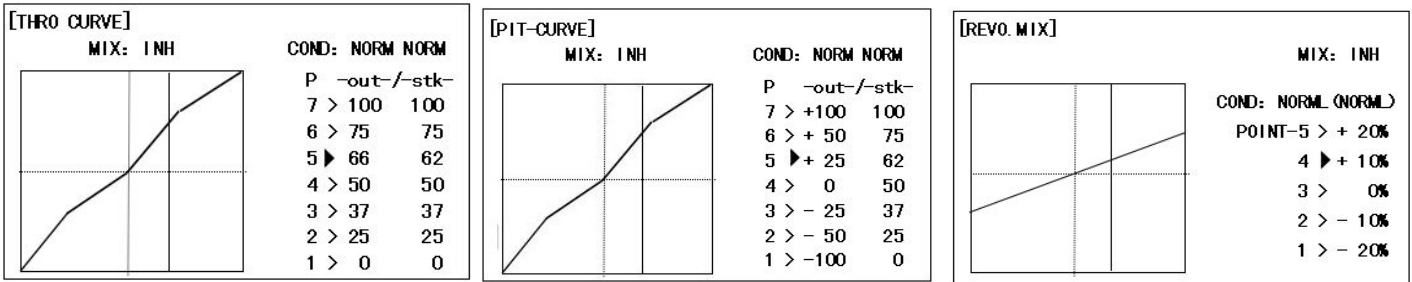

- **THR-CURV/NOR:** inputs the normal (**NORM**) throttle curve, which is usually not a linear response to **THROTTLE STICK** motion. Adjusting point 4 of the curve adjusts the engine’s RPM at the **THROTTLE STICK** midpoint . the desired position for hovering. The other 6 points are then adjusted to create the desired idle and maximum engine speed, and a smooth transition in-between. For more on throttle curves, see p. 80.
- **PIT-CURV/NOR:** inputs the normal (**NORM**) collective pitch curve, the collective pitch curve for flight near hover. The normal collective pitch curve is adjusted to match the throttle curve, providing the best vertical performance at a constant engine speed, with a starting curve of .4 base, +5 neutral, and +8 to +10 degrees of blade pitch maximum*. You can program the response over a 7-point curve for the best collective pitch angle relative to **THROTTLE STICK** movement. For more on collective pitch curves, see p. 80
- **REVO./NORM:** mixes collective pitch commands to the rudder (a **PITCH-RUDDER** mix) to suppress the torque generated by changes in the main rotor's collective pitch angle, keeping the model from yawing when throttle is applied.

NOTE: There are three revo. mixes available: normal (**NORM**), idle-up 1 / 2 (**IDL1/2**), and idle-up 3 (**IDL3**). All 3 are adjustable in the **ADVANCE** menu. Never use revo. mixing in conjunction with heading-hold/AVCS gyros. For details on revo, including default points for clockwise and counterclockwise rotating rotors, see p. 80.

*These default recommendations assume you are doing forward flight. If you are just learning, please follow your instructor’s guidance. Some instructors like a +1 base point for training so that the helicopter comes down very slowly, even if your instincts pull the throttle/collective stick to the bottom in a hurry.

GOAL of EXAMPLE:	STEPS:	INPUTS:
<p>Set up Normal Flight Condition Throttle/Collective Pitch Curves and Revo.</p> <p><i>Base point:</i> Adjust base point of throttle curve until engine idles reliably on ground. Adjust base point of collective pitch curve to achieve -4 degrees of blade pitch. Apply throttle until the model sits 'light' on its skids. Adjust base point of REVO. until model does not rotate its nose at all.</p>	Open the THR-CURV/NOR function. Adjust the first point. (Ex: 5% .)	(MODE) for 1 second. (If ADVANCE , (MODE) again.) ⊙ to THR-CURV/NOR. ⊙ ⊙ to POINT-1. ⊙ to 5%. (END)
	Open the PIT-CURV/NOR function. Adjust the first point. (Ex: 8% .)	⊙ to PIT-CURV/NOR. ⊙ ⊙ to POINT-1. ⊙ to 8%. (END)
	Open the REVO./NORM function. Adjust the first point. (Ex: 4% .)	⊙ to REVO./NORM. ⊙ ⊙ to MIX. ⊙ to ON. ⊙ to POINT-1. ⊙ to 4%. (END)
<p><i>Hover point:</i> Adjust collective pitch curve to +5 degrees. Ease heli into a hover. Land/shut engine off. Adjust throttle curves and rudder trim. Repeat until model hovers smoothly at half throttle. Rapidly apply throttle from 1/4 to 1/2 stick. Adjust REVO. points 2 and 3 until the model does not rotate its nose up on throttle application.</p>	Adjust THR-CURV/NOR.	Repeat above as needed.
	Adjust PIT-CURV/NOR.	Repeat above as needed.
	Adjust REVO./NORM.	Repeat above as needed.
<p><i>High point:</i> Adjust collective pitch curve to +8 to +10 degrees. From hover, throttle up rapidly. If engine bogs, increase the throttle curve. If engine over-revs, increase the collective pitch curve at points 6 or 7. Apply full throttle while hovering, then descend back to hover. Adjust REVO. until the nose does not change heading.</p>	Adjust THR-CURV/NOR.	Repeat above as needed.
	Adjust PIT-CURV/NOR.	Repeat above as needed.
	Adjust REVO./NORM.	Repeat above as needed.
<p><i>Where next?</i></p>	<p>GYRO function: see p. 85. Adjust HOV-THR and HOV-PIT if needed: see p. 83. Setting up Throttle Hold: see p. 79. Setting up idle-ups 1, 2 and 3: Throttle and collective pitch curves and revo. mixing (THR-CURVE, PIT-CURVE, REVO. MIX): see p. 80. GOVERNOR function: see p. 87. D/R,EXP: see p. 30.</p>	

<p>[THR CUT] MIX: INH RATE: 0% THRO: 5% (75%) SW: SwH POS1: DOWN</p>

THROTTLE CUT:

The **THROTTLE-CUT** function is used to kill the engine at the end of a flight. The engine can be stopped with one touch of any switch, eliminating the need to move the trim to kill the engine and then readjust prior to each flight. The helicopter **THROTTLE-CUT** includes an ON/OFF throttle position (normally a little above idle). You must move the **THROTTLE STICK** back below the set point before the **THROTTLE-CUT** function can be reset, to avoid sudden engine acceleration. For a detailed example of throttle cut setup, see **ACRO** p. 29.

Note: Be sure to add the step of setting a trigger point by cursoring to **THRO**, then putting the **THROTTLE STICK** in the desired position and pressing and holding the dial for one second. Notice that this function cannot be reversed to trigger only above the stick point.

HELI-SPECIFIC ADVANCE MENU FUNCTIONS

THR-HOLD: This function holds the engine in the idling position and disengages it from the *THROTTLE STICK* when *SWITCH AT10* is moved. It is commonly used to practice auto-rotation.

```
[THR-HOLD]
MIX▶INH
POSI▶ 0%
```

Prior to setting up **THR-HOLD**, hook up the throttle linkage so that the carburetor is opened fully at high throttle, then use the digital trim to adjust the engine idle position. To have **THR-HOLD** maintain idle, move the *THROTTLE STICK* to the idle position, then move the hold SWITCH on and off and keep changing the offset value until the servo does not move. To lower the engine idle speed, or if you want to shut off, input a more negative number.

Adjustability:

- *Idling position:* Range of **-50%** to **+50%** centered about the throttle idle position to get the desired engine RPM.
- *Switch assignment:* Assigned to *SWITCH E(AT10)* or *G (AT10)* down. Adjustable in the **CONDITION (THR-HOLD)** item. (2-position type switch only)
- *Throttle curve:* Since the throttle is moved to a single preset position, no curve is available for **THR-HOLD**.
- *Collective pitch curve:* Independent curve, typically adjusted to create a blade pitch range of -4% to +10% to +12%, is automatically activated with **THR-HOLD**.
- *Revo. mix:* Since revo. mix adjusts for torque from the engine, no revo. mix is available for **THR-HOLD**.
- *Priority:* The throttle hold function has priority over idle-up. Be sure that the throttle hold and idle-up *SWITCHES* are in the desired positions before trying to start the engine. (We recommend starting your engine in throttle hold for safety reasons.)
- *Gyro:* Gyro programming includes an option to have a separate gyro setting for each condition, including **THR-HOLD**. This avoids the potential problem of the user being in the wrong gyro setting when going to **THR-HOLD**, resulting in an improper rudder offset and the model pirouetting.

[CONDITION]		
	-sw-	-pos-
IDLE-UP1: INH	SwE	CENT
2: INH	SwE	DOWN
3: INH	SwF	DOWN
THR-HOLD: OFF	SwG	DOWN

GOAL of EXAMPLE:	STEPS:	INPUTS:
Set up throttle hold.	Open THR-HOLD function.	(MODE) for 1 second. (If BASIC , (MODE) again.) ◊ to THR-HOLD . ☀
Determine desired throttle position by idling engine, turn on THR-HOLD , and adjust percentage as required to reach the desired running point.	Activate the function.	◊ to MIX . ☀ to OFF .
	Set desired engine position.	◊ to POSI . ☀ to desired percent.
	Close.	(END) (END)
<i>Where next?</i>	PIT-CURVE for THR-HOLD: see p. 80. DELAY for THR-HOLD (to ease collective pitch response): see p. 82. GYRO setup: see p. 85. Setting up the Idle-Ups: Throttle and Collective pitch Curves and Revo. Mixing(TH-CURVE, PIT-CURVE, REVO. MIX) for idle-ups: see p. 80. D/R, EXP: see p. 30.	

THR-CURVE and **PIT-CURVE**: These 7-point curves are utilized to best match the blade collective pitch to the engine RPM for consistent load on the engine. Curves are separately adjustable for normal, idle-up 1, idle-up 2, and idle-up 3. In addition, a separate collective pitch curve is available for throttle hold. Sample curves are displayed in the appropriate setup types (ex: normal flight condition) for clarity.

Suggested defaults:

- Normal: Collective pitch curve that results in points 1, 4 and 7 providing .4, +5, (+8 to +10)* degrees pitch. A throttle curve setting of 0, 25, 36, 50, 62.5, 75, 100%.
- Idle-ups 1 & 2: Idle-ups 1 and 2 are typically the same except for the gyro settings, with one being heading-hold/AVCS and the other being normal mode. The pitch curve will likely be similar to the normal curve above.
- Idle-up 3: Collective pitch curve that results in points 1, 4 and 7 providing (.8 to .10), 0, (+8 to +10) degrees. A throttle curve of 100, 75, 62.5, 50, 62.5, 75, 100 to provide full throttle for inverted maneuvers.
- Throttle Hold pitch curve: Start with the normal pitch curve (for inverted autos, start from the idle-up 3 pitch curve), but increase the last point approximately 1-2°, if available, to ensure sufficient pitch at landing.

*(These default recommendations assume you are doing forward flight. If you are just learning, please follow your instructor's guidance. Some instructors like a +1 base point for training so that the helicopter comes down very slowly, even if your instincts pull the throttle/collective stick to the bottom in a hurry.)

Adjustability:

- Normal condition curves are editable in the **BASIC** menu for convenience.
- All curves may be adjusted in the **ADVANCE** menu.
- Automatically selected with the proper condition.
- The idle-up curves are programmed to maintain constant RPM even when the collective pitch is reduced during flight (including inverted).
- To change which condition's curve is being edited, cursor up to **COND>** and change the curve named.
- For clarity, the name of the condition currently active (switched on in the radio) is shown in parentheses behind name of condition whose curve is being edited. (Example: see curve displays below. Note that the normal condition is active but the idle-up 1 condition's curves are currently being edited.)
- *Moving and deleting the curve point*: The curve point (**-stk-**) can be moved to the left or right by turning the **DIAL** (up to 2% in front of the adjoining point) and deleted/returned by pressing the **DIAL** for one second alternately.
- *Copying the curve*: To copy the current curve onto another condition's curve, cursor up to **COND>** and press the **DIAL** for one second. Then select to desired condition and press the **DIAL** for one second.
- Idle-ups and throttle hold pitch curves may be edited even before the conditions have been made active. Activating their throttle curves activates these conditions.

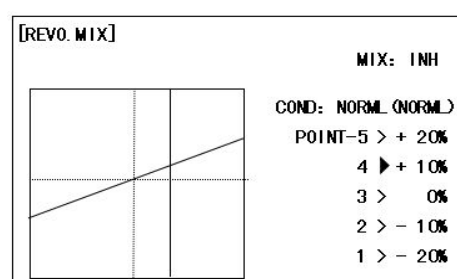
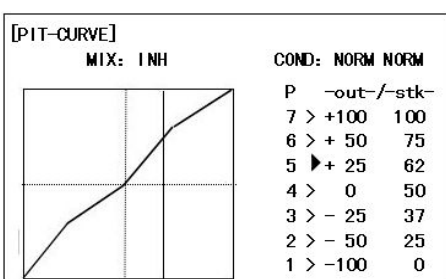
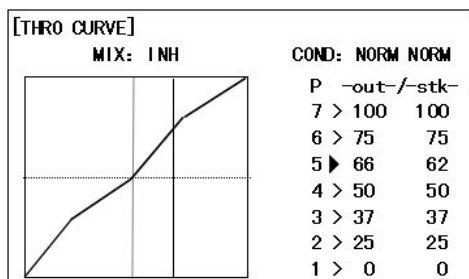

REVO. MIX: This 5-point curve mix adds opposite rudder input to counteract the changes in torque when the speed and collective pitch of the blades is changed.

Adjustability:

- Three separate curves available: normal for hovering; idle-ups 1 and 2 combined; and idle-3.
- Normal condition curves are editable in the **BASIC** menu for convenience.
- All curves may be adjusted in the **ADVANCE** menu.
- Correct mix is automatically selected in-flight with each condition and automatically activated when the throttle setup for that condition is activated in the programming (i.e. **THROTTLE HOLD** or **THR-CURVE**.)
- To change which condition's curve is being edited, cursor up above **POINT5** and select. For clarity, the name of the condition currently active (switched on at the radio) is shown in parentheses behind the name of the condition whose curve is being edited.

Revo. mixing rates are 5-point curves. For a clockwise-turning rotor, the rudder is mixed in the clockwise direction when collective pitch is increased; for counterclockwise-turning, the opposite. Change the operating direction setting by changing the signs of the numbers in the curve from plus (+) to minus (-) and vice versa. Suggested defaults:

Clockwise rotation: -20, -10, 0, +10, +20% from low throttle to high.
 Counterclockwise rotation: +20, +10, 0, -10, -20% from low throttle to high.
 Adjust to the actual values that work best for your model.

Revo. curves for idle-ups are often v-shaped to provide proper rudder input with negative pitch and increased throttle during inverted flight. (Rudder is needed to counter the reaction whenever there is increased torque. In inverted flight, throttle stick below half has increased throttle and negative pitch, therefore increasing torque and rotating the helicopter unless the revo. mix is also increasing appropriately.)

IDLE-UPS: additional flight conditions available specifically for helicopters. These additional flight conditions contain different throttle curves, collective pitch curves, revo. mixing, and trims (except **IDLE-3**) to make the helicopter perform certain maneuvers more easily. Lastly, the gyro and dual rate functions may be set to provide separate rates per condition selected, including one for each idle-up.

One of the most common flight conditions can easily flip from upright to inverted and back. To do so, the pitch curve is set to 0 pitch at half stick, positive pitch (climb upright) above half, and negative pitch (climb when inverted) below half stick. The throttle curve is adjusted to allow the engine to run consistently throughout the changes in pitch.

Additional idle-ups may be used to maximize the helicopter's flight characteristics in certain types of flight (i.e. fast forward motion, backward) or maneuvers (loops, rolls, stall turns), or even the same maneuver but changing from heading-hold/AVCS gyro mode to normal gyro mode. The AT10 provides 3 idle-ups to allow the modeler 3 additional setups along with the normal flight condition. (Note that **IDL3** does not include governor settings.)

Adjustability:

- **SWITCH G** (AT10) or **E** (AT10) is programmed for normal (**NORM**), idle-up 1 (**IDLE-UP1**), and idle-up 2 (**IDLE-UP2**) curves.
 Adjustable in the **CONDITION SELECT (IDLE-UP1/2, IDLE-UP3)** items).
 (**IDLE-UP1/2** 3-position type switch only, **IDL3** 2-position type switch only)
- Activated with the throttle curve for that condition in **THR-CURVE**.
- Curves are adjusted to maintain constant RPM even when the collective pitch is negative (inverted).
- Note that **REVO**.mixing has one curve for idle-ups 1 and 2 and a second curve just for idle-up3.
- Gyro settings may be set separately for each idle-up. (See p.81)
- Governor settings may be set up to follow Normal/Idle1/Idle2, but do not offer a setting to adjust for each of the 5 conditions like gyro. (See p. 81.)
- Activating **OFFSET** makes the **TRIM LEVERS** adjust the trim separately in each of the idle-up conditions.

[CONDITION]	-sw-	-pos-
IDLE-UP1: 1NH	SwE	CENT
2: 1NH	SwE	DOWN
3: 1NH	SwF	DOWN
THR-HOLD: OFF	SwG	DOWN

For an example of throttle and pitch curves and revo, please see Normal Flight Condition Setup, p. 78.

OFFSET: Optional separate trims in addition to those for the normal condition. This function is used to automatically change the trim of a helicopter, for example, when transitioned from hover to flying at high speed. A clockwise-rotation rotor helicopter tends to drift to the right at high speed, so an aileron offset may be applied to offset the helicopter to the left. The necessary elevator offset varies with model geometry, so it must be determined by noting collective pitch changes at high speed. The rudder offset is affected by both revo. mixing and trim lever movement while in the offset function.

[OFFSET]		
MIX:	INH	
NO:	IDL1	(NORM)
RATE-	AILE:	0%
	ELEV:	0%
	RUDD:	0%
	SW:	Cond

Adjustability:

- Complete switch assignability, plus a **CONDITION** option that creates/switches between individual trims for each of the idle-ups.
- When **OFFSET** is active (its switch is on), moving the **TRIM LEVERS** adjust the stored offset, not the trims in the normal condition.
- When **OFFSET** is inactive (its switch is off), the **OFFSET** and any trim adjustments to it have no effect (model obeys the trim settings of the currently-active flight condition.)
- When **OFFSET** is inhibited, trim adjustments made in any flight condition affect all flight conditions.
- Rapid jumps caused by large offsets can be slowed using the **DELAY** function.

*During **OFFSET** operation, the aileron, elevator, and rudder travels are displayed on each trim display in the Startup screen.

NOTE: Remember, offsets and revo. mixes are not recommended when using heading-hold/AVCS gyros because they conflict with the automatic corrections to trim and torque that AVCS provides.

GOAL of EXAMPLE:	STEPS:	INPUTS:
Set up separate trims for each of the three idle-up conditions.	Open the OFFSET function.	(MODE) for 1 second. (If BASIC , (MODE) again.) ◂ to OFFSET . ⚙️
Adjust the idle-up 2 rudder trim to correct for torque at high speeds.	Activate the function.	◂ to MIX . ⚙️ to OFF or ON .
	Change switch setting to Cond . (No need to change SW .)	already Cond .
	Select IDL2 .	◂ to No . ⚙️ to IDL2 .
	Adjust trim settings as needed. (Ex:rudder to +8% .)	◂ to RUDD . ⚙️ to +8% .
	Close menus and confirm difference in trims between normal and idle-up 2.	(END) (END) ⬆️ E (AT10) or G (AT10) from NORMAL to IDL2 . Check that rudder trim changes.
<i>Where next?</i>	DELAY: see p. 82. THR-HOLD: see p. 79. Setting up the Idle-Ups: Throttle and Collective pitch Curves and Revo. Mixing (THR-CURVE, PIT-CURVE, REVO. MIX) for idle-ups: see p. 80.	

DELAY: The Delay function provides a smooth transition between the trim positions whenever **OFFSET**, **REVO. MIXING**, or **THROTTLE HOLD** functions are turned on and off.

[DELAY]		
RATE-AILE▶	0% (OFF)	
ELEV▶	0% (OFF)	
RUDD▶	0% (OFF)	
THRO▶	0% (OFF)	
PITC▶	0% (OFF)	

Adjustability:

- Separate delay times are available for aileron, elevator, rudder, throttle, and pitch.
- With a 50% delay setting, the servo takes about a half-second to move to its new position...quite a long time.
- In general, delays of approximately 10-15% are sufficient.

GOAL of EXAMPLE:	STEPS:	INPUTS:
Set up a delay on all channels to ease the transition from one flight condition to another so there are no "hard jumps."	Open the DELAY function.	(MODE) for 1 second. (If BASIC , (MODE) again.) ⊙ to DELAY . ⚙
	Adjust AILE response as needed. (Ex: aileron to +8% .)	⚙ to +8% .
	Repeat for other channels.	⊙ to ELEV . Repeat step above.
	Close menus and confirm slowed transitions.	(END) (END) ⬇ E (AT10) or G (AT10) from NORMAL to IDL2 . Check that servos move gradually to new positions.
Where next?	THR-HOLD : see p. 79. Setting up the Idle-Ups: Throttle and Collective pitch Curves and Revo. Mixing (THR-CURVE, PIT-CURVE, REVO. MIX) for idle-ups: see p. 80.	

HOVERING ADJUSTMENTS (HOV-THR and HOV-PIT):

Hovering throttle and hovering pitch are fine-tuning adjustments for the throttle and collective pitch curves individually, affecting performance only around the center point and only in the normal condition. They allow in-flight tweaking of the curves for ideal setup.

```
[HOV-THR]

MIX: ON
RATE:  0% (+ 87%)
VR: +VrC
MODE: NORM
```

```
[HOV-PIT]

MIX: INH
RATE:  0% (+ 89%)
VR: +VrA
MODE: NORM
```

Adjustability:

- Rotor speed changes caused by temp., humidity, altitude or other changes in flying conditions are easily accommodated.
- Both adjustments may be inhibited if not desired.
- Both adjustments may also be set to **NULL**, temporarily turning off the knob but maintaining the last memorized setting.
- Adjustments may be memorized and then the knobs returned to center point to use that amount of adjustment. Allows easy use of the trimming knobs for multiple models. (Note that when memorization is repeated with the knob offset from center, the trim value accumulates.)
- Adjustments are quickly reset to the initial value by turning the dial until the trim reads 0%, memorizing, then returning the knob to its center position.
- Note that all functions, including these, assume the model hovers at half stick.
- Available in normal (**NORM**) or normal/idle-up 1 (**NORM/IDL1**) condition only.

GOAL of EXAMPLE:	STEPS:	INPUTS:
<p>Fine-tune hovering with the hovering adjustments. Remember these affect only the hovering (normal) condition.</p> <p>Adjust throttle and collective pitch curves until model hovers nicely. In flight, adjust collective pitch and throttle curves near hover point independently with HOV-THR and HOV-PIT knobs.</p> <p>Store new settings after flight.</p>	Open the HOV-THR function.	for 1 second. (If BASIC , again.) to HOV-THR .
	<i>Optional: change which knob adjust seach hovering curve. NULL locks in curve in last stored position.</i>	to VR . to desired knob and direction.
	Store the current dial settings prior to selecting another model.	to RATE . for one second to store. or VR(C) to center.
	Close.	
	Open the HOV-PIT function.	to HOV-PIT .
	Store the current dial settings prior to selecting another model.	to RATE . for one second to store. or VR(A) to center.
	Close.	
Where next?	THR-HOLD : see p. 79. Setting up the Idle-Ups: Throttle and Collective pitch Curves and Revo. Mixing (TH-CURVE, PIT-CURVE, REVO. MIX) for idle-ups: see p. 80. D/R,EXP : see p. 30.	

HIGH/LOW PITCH (HI/LO-PIT):

This function may be used to adjust the curves high and low side individually for each flight condition (normal, idle-up 1, idle-up 2, idle-up 3, throttle hold).

[HI/LO-PIT]	
COND: NORM (NORM)	
HI-PIT: 100% (100%)	
ADJ: MANUAL	VR: +VrE
LO-PIT: 100% (100%)	
ADJ: MANUAL	VR: -VrD

Adjustability:

- You may define high and low side rate trim knobs (the high side pitch trim control is defined as the right side lever at initial setting).
- The conditions are activated in the **CONDITION SELECT** function (p.81).
- Both adjustments may be set to **MANUAL**, temporarily turning off the knob.
- Adjustments may be memorized and then return the knobs to center point to use that amount of adjustment. Allows easy use of the trimming knobs for multiple models.

GOAL of EXAMPLE:	STEPS:	INPUTS:
Set up a high pitch curve in the idle-up 1 condition. Store new settings after flight.	Open the HI/LO-PIT function.	(MODE) for 1 second. (If BASIC , (MODE) again.) ⊕ to HI/LO-PIT . ⊕
	Select the idle-up 1 condition.	⊕ to NORM . ⊕ to IDL1 .
	Set the rate. (Ex: 80%)	⊕ to HI-PIT . ⊕ to 80% .
	<i>Optional: change which knob adjusts high pitch curve.</i>	⊕ to VR . ⊕ to desired knob and direction.
	Store the current dial settings prior to selecting another model.	⊕ to HI-PIT . ⊕ for one second to store. ⊕ or ⊕ VR(E) to center.
Close.	(END) (END)	
Where next?	PIT-CURVE : see p. 80. HOV-PIT : see p. 83.	

GYROS and GOVERNORS: Using electronics to take some of the complexity out of setups and flight.

What is a gyro? A gyroscope is an electronic unit that senses motion and corrects for it. For example, if the wind blows your helicopter's tail to the left, a gyro will sense that motion (and confirm that no input was given) and will correct for it.

How does it help in helicopter setup? A good gyro will totally eliminate the need for revo. mixing. The gyro will sense and correct the unwanted motion for you, so you don't have to spend time to get a complex curve operating properly.

Adjustability:

- Plug the gyro's sensitivity adjustment to channel 5 of the receiver. (not assignable)
- **STD** and AVCS/Heading-hold (**GY**) setup types available to simplify adjustments for AVCS/Heading-hold gyros.
- Full switch assignability or may select **Cond.** option.
- **Cond.** option provides separate gyro settings, one for each condition, automatically selected with the condition. Allows changes in gain to meet the specific needs of each flight condition.
- Each gyro setting may be set from 0 to +100 (**NOR**100% to **AVC**100%) gain, equating to ATV settings of -100% to +100%.
- Dual mode gyros (heading-hold/AVCS and normal) are easily triggered to each mode by changing the gyro setting's sign. Negative settings trigger normal mode; positive settings are AVCS mode.
- Larger percentages indicate more gain, or gyro responsiveness.
- Tail wagging or shaking indicates excessive gain settings. Turn down gyro setting until wag stops.

Gain Example for AVCS/Heading-hold Gyros (GY)

```

[GYRO SENSE]
MIX: INH
MODE: STD
SW: SwF
RATE-UP      50%
DOWN ▶      50%

```

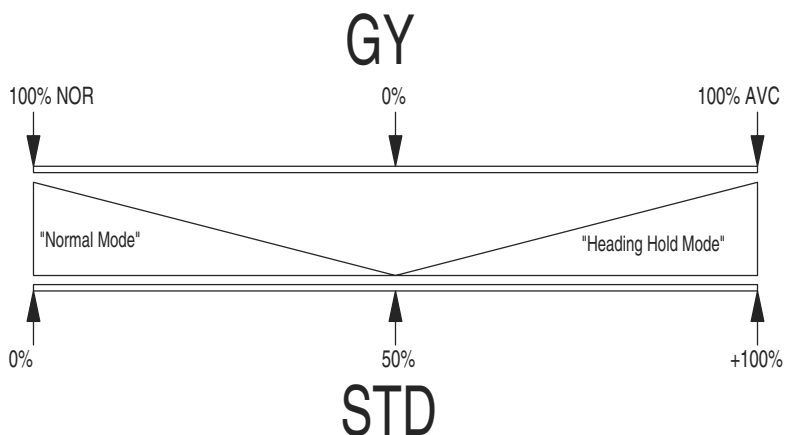

GOAL of EXAMPLE:	STEPS:	INPUTS:
Set up a heading-hold/AVCS gyro with heading-hold/AVCS setting in idle-ups 1 and 2 and normal mode setting in idle-up3 and normal.	Open and activate the GYRO SENSE function.	(MODE) for 1 second. (If BASIC , (MODE) again.) ⌚ to GYRO SENSE . ⌚
	Activate the function.	⌚ to MIX . ⌚ to ACT .
	<i>Optional: change gyro type to Heading-hold (GY).</i>	⌚ to MODE . ⌚ to GY .
	<i>Optional: change switch assignment. Ex: select Cond.</i>	⌚ to SW . ⌚ to Cond .
	Adjust gyro rates as needed. (Ex: NORM , IDL3 to NOR 50% . IDL1 and 2 to AVC 50% as starting points.)	⌚ to NORM . ⌚ to NOR 50% . ⌚ to IDL1 . ⌚ to AVC 50% . Repeat.
	Close the function.	(END) (END)
Where next?	GOVERNOR: see p. 87. D/R,EXP: see p. 30. DELAY: see p. 82.	

GOVERNORS:

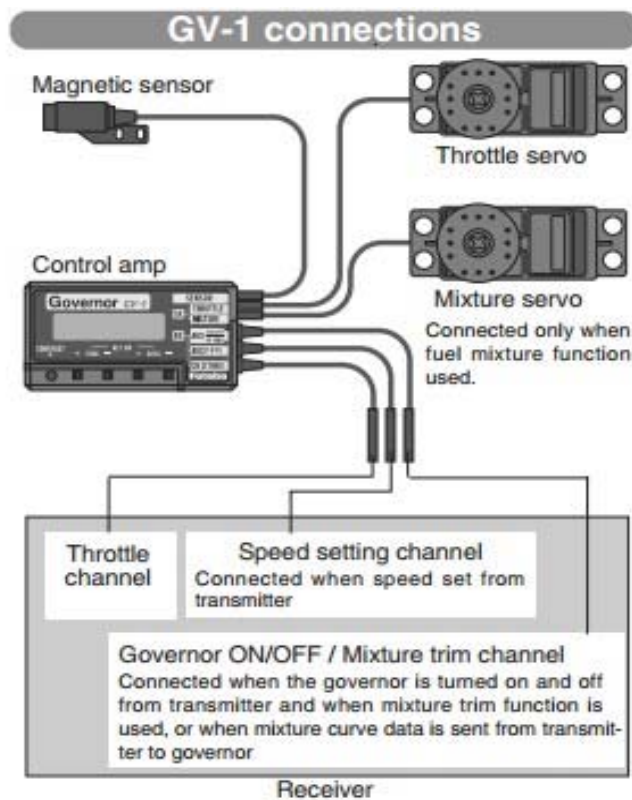

What is a governor? A governor is made up of a set of sensors which read the RPM of the helicopter's head, and a control unit that automatically adjusts the throttle setting to maintain a constant head speed regardless of changes in pitch of blades, weather conditions, etc. Governors are extremely popular in competition helicopters due to the consistency provided.

How does it help in helicopter setup? The governor eliminates the need to spend large amounts of time setting up throttle curves, as it automatically adjusts the engine's RPM to maintain the desired head speed.

GOVERNOR: The Governor mixing function is used to adjust the Governor speed settings (rS1, rS2, rS3) from the transmitter. (If you are using a different governor, follow the manufacturer's instructions.)

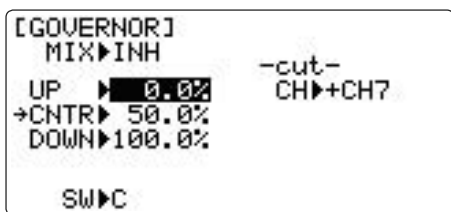

Adjustability:

- On/off may be separate from speed switching by plugging governor on/off into ch8 and changing CUT-CH setting.
- If using separate on/off, switch assignment is totally adjustable. Be careful not to assign governor off to a condition switch if you want the governor to function in that condition.
- Speed switching and governor ON/OFF may be together using one switch or ON/OFF switching may be performed using an independent switch/channel.
- When speed setting control uses CH7 and separate ON/OFF switch is not used, CH8 can be used for other functions.
- In-flight adjustment of the head speed (for easy adjustment during tuning) may be created using an additional channel and a programmable mix. See www.radiolink.com.cn/doce for details.

The GV-1 controls throttle when it is active, so the throttle will not obey any FailSafe settings preset for throttle in the transmitter. Always set the FailSafe setting for the GV-1's on/ off channel to OFF. This way the governor is shut off and the throttle obeys the FailSafe throttle commands.

Expert Tip: Mounting the Governor to the counter gear instead of the fan dramatically simplifies installation in many models.

Setting example: When speed and ON/OFF are using one switch:

Governor Speed	Switch Position (Switch C or Cond.)	Rate (%)	Adjustment from Tx.
RS1: OFF	UP or NORM	0	Use up to 0%. (Governor speed display reads "off".)
RS2: 1400	CNTR or IDL1	50	Speed adjusted by raising and lowering rate.
RS3: 1700	DOWN or IDL2	100	Speed adjusted by lowering rate.

*The relationship of the governor speed setting rS1~rS3 and the switch positions conforms to the table above.

*In throttle hold, always check that the governor is off.

*If the speed value rises when the cut switch is activated, reverse the "DIR" setting from **UP** to **DOWN** or vice versa.

GOAL of EXAMPLE:	STEPS:	INPUTS:
Set up a governor to use both channels into the receiver and switch between the governor settings automatically when changing conditions. Consider setting the battery Fail Safe settings and other helpful functions on the Governor itself.	Open and activate the GOVERNOR function.	Ⓜ for 1 second. (If BASIC , Ⓜ again.) ⤴ to GOVERNOR . ⚙
	Activate the function.	⤴ to MIX . ⚙ to ACT .
	<i>Optional: change cut-off channel to channel 8 and assign switch and direction for on/off (channel 8).</i>	⤴ to cut- CH ⚙ to +CH8 . ⤴ to cut- SW . ⚙ to desired SWITCH .
	<i>Optional: change switch assignment to select governor settings. Ex: select switch that selects the conditions.</i>	⤴ to SW . ⚙ to Cond .
	Adjust governor speed settings per switch position or condition as needed. (Ex: defaults are fine.) Allows head speed adjustment from transmitter.	⤴ to each Cond position. ⚙ or ⚙ as needed. ⤴ to next Cond position. Repeat.
	Close the function.	Ⓜ Ⓜ
<i>Where next?</i>	GYRO : see p. 85. Adjust FailSafe (F/S) settings (p. 37). Adjust idle-up 3 collective pitch curve for same rates of climb upright/inverted. See p. 80. Adjust elevator/aileron response to fit your flying style: see D/R,EXP and END POINT/SWASH AFR : p. 30, 27, 75.	

Postback and Monitor real time flight message: The AT10 and receiver R10D can monitor real time RSSI and receiver voltage.

RSSI is shown in the figure below, Simultaneously, users can check the specific signal strength in Sensor View.

Receiver voltage post back and monitor: RX.

External flight battery voltage: EXT.

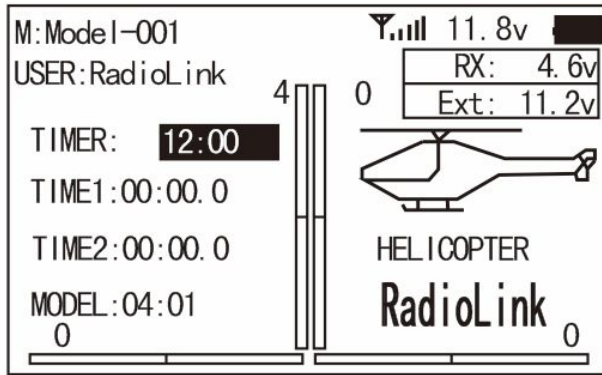

Sensor View:

In Basic Menu,Select “Servo View” and press ”Push” button to enter Sensor View,then user can check detailed post back information for the aircraft.

The details are as following figures, user can check flight message like temperature and rate sensor,GPS.

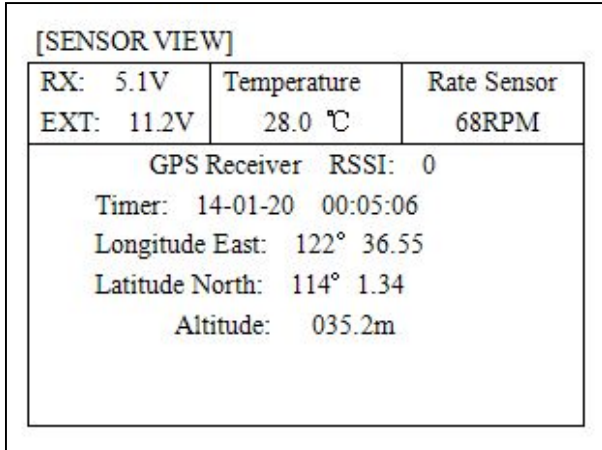

RX: Receiver voltage postback and monitor

EXT: External Power battery voltage

RSSI: Received Signal Strength Indicator

NULL: No signal

0 : Strongest signal.

Note: If user want to check EXT/Rate/Temperature/GPS in the AT10 radio, people need to use the external module.

External module Connection:

External flight battery sensor , temperature sensor, rate RPM sensor, GPS sensor.

When the telemetry function is used to send receiver information to the transmitter,telemetry sensors are connected to the receiver as follows:

The telemetry hub and voltage sensor is connected to the flight battery and the receiver data port. Subsequently the actual supply voltage will be displayed on the transmitter screen.

Additional sensors may be connected in series with the telemetry hub and voltage sensor to supply transmitter display of receiver voltage, and temperature, motor rpm, altitude or gps information.

Telemetry sensor can recognize the battery type and automatically alarm when the voltage of the single cell is less than 3.7V.

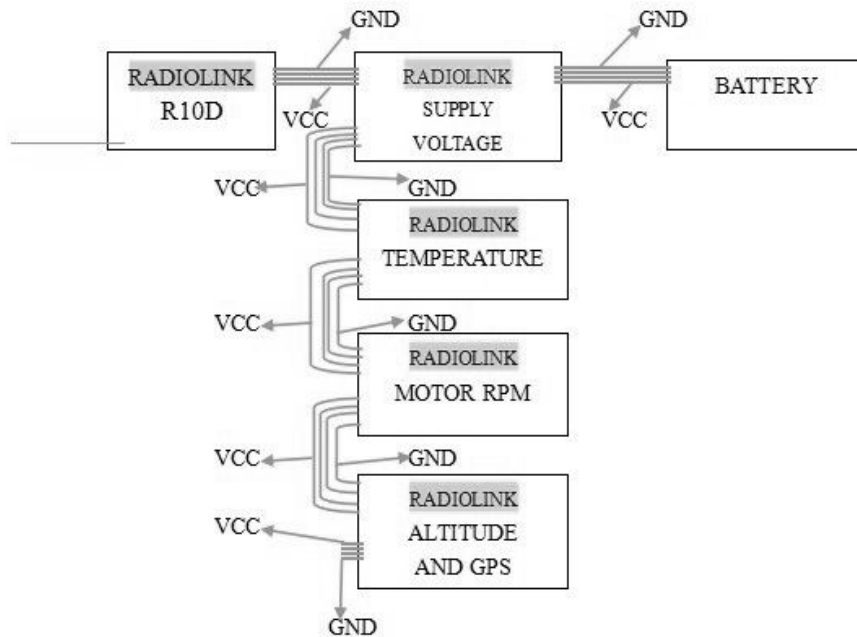

Supply Voltage Sensor Connection:

The module is connected in series to receiver R10D 4-pin data series interface as follows:

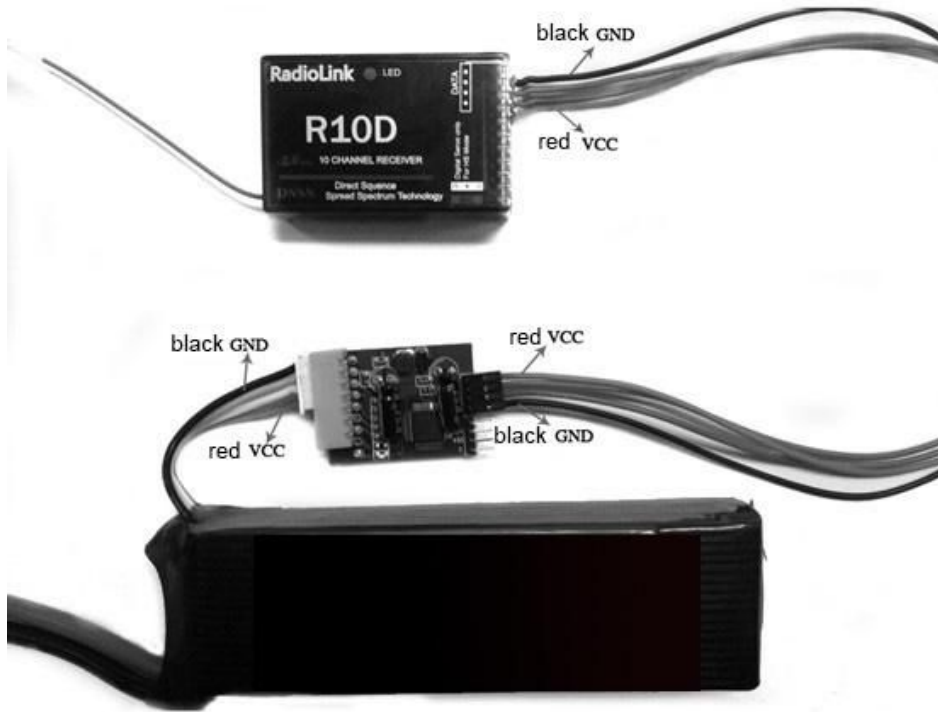

Technical Parameter:

1. Dimension: 18×9.5×22cm;
2. Weight: 0.95kg;
3. Frequency: 2.4GHz ISM band (2400MHz~2485MHz);
4. Modulation mode: QSPK;
5. Channel bandwidth: 5.0MHz;
6. Spread spectrum: DSSS;
7. Adjacent channel rejection: > 38dBm;
8. Transmitter power: < 100mW (PCB testing),
< 20dBm (3 meter air testing);
9. Operating Voltage: TX 8.6~15V
RX 4.6~10V
10. Operating Current: < 95mA;
11. Control distance: 1100 meters ground; 2000 meters air.
12. Channel: 10 Channel, 8~10 channel are customizable;
13. Compatible model: Include all 120 degree and 90 degree swash-plate helicopter, all fixed wing and glider, five flying model;
14. Simulator mode: under the simulator model the transmitter action turns off, change to power saving mode;
15. Screen: 16 bit colorful screen, size 78×52mm, 320*480 pixel.